

DENON

DNP-F109
NETWORK AUDIO PLAYER

Owner's Manual

SAFETY PRECAUTIONS



CAUTION

RISK OF ELECTRIC SHOCK

DO NOT OPEN



CAUTION:
TO REDUCE THE RISK OF ELECTRIC SHOCK, DO NOT REMOVE COVER (OR BACK). NO USER-SERVICEABLE PARTS INSIDE. REFER SERVICING TO QUALIFIED SERVICE PERSONNEL.

The lightning flash with arrowhead symbol, within an equilateral triangle, is intended to alert the user to the presence of uninsulated "dangerous voltage" within the product's enclosure that may be of sufficient magnitude to constitute a risk of electric shock to persons.

The exclamation point within an equilateral triangle is intended to alert the user to the presence of important operating and maintenance (servicing) instructions in the literature accompanying the appliance.

WARNING:
TO REDUCE THE RISK OF FIRE OR ELECTRIC SHOCK, DO NOT EXPOSE THIS APPLIANCE TO RAIN OR MOISTURE.

IMPORTANT SAFETY INSTRUCTIONS

1. Read these instructions.
2. Keep these instructions.
3. Heed all warnings.
4. Follow all instructions.
5. Do not use this apparatus near water.
6. Clean only with dry cloth.
7. Do not block any ventilation openings. Install in accordance with the manufacturer's instructions.
8. Do not install near any heat sources such as radiators, heat registers, stoves, or other apparatus (including amplifiers) that produce heat.
9. Protect the power cord from being walked on or pinched particularly at plugs, convenience receptacles, and the point where they exit from the apparatus.
10. Only use attachments/accessories specified by the manufacturer.
11. Use only with the cart, stand, tripod, bracket, or table specified by the manufacturer, or sold with the apparatus. When a cart is used, use caution when moving the cart/apparatus combination to avoid injury from tip-over.
12. Unplug this apparatus during lightning storms or when unused for long periods of time.
13. Refer all servicing to qualified service personnel. Servicing is required when the apparatus has been damaged in any way, such as power-supply cord or plug is damaged, liquid has been spilled or objects have fallen into the apparatus, the apparatus has been exposed to rain or moisture, does not operate normally, or has been dropped.
14. Batteries shall not be exposed to excessive heat such as sunshine, fire or the like.



CAUTION:

To completely disconnect this product from the mains, disconnect the plug from the wall socket outlet.
 The mains plug is used to completely interrupt the power supply to the unit and must be within easy access by the user.

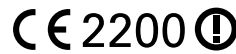

R&TTE Directive 1999/5/EC

This product may be operated in the following countries;

AT	BE	CZ	DK	FI
FR	DE	GR	HU	IE
IT	NL	PL	PT	SK
ES	SE	GB	NO	CH

Indoor use only.

DECLARATION OF CONFORMITY

We declare under our sole responsibility that this product, to which this declaration relates, is in conformity with the following standards: EN60065, EN55013, EN55020, EN61000-3-2, EN61000-3-3, EN300328, EN301489-01, EN301489-17 and EN50371.
 Following the provisions of Low Voltage Directive 2006/95/EC and EMC Directive 2004/108/EC, the EC regulation 1275/2008 and its frame work Directive 2009/125/EC for Energy-related Products (ErP).

DENON EUROPE
 Division of D&M Germany GmbH
 An der Kleinbahn 18, Nettetal,
 D-41334 Germany

A NOTE ABOUT RECYCLING:

This product's packaging materials are recyclable and can be reused. Please dispose of any materials in accordance with the local recycling regulations.

When discarding the unit, comply with local rules or regulations.

Batteries should never be thrown away or incinerated but disposed of in accordance with the local regulations concerning battery disposal.

This product and the supplied accessories, excluding the batteries, constitute the applicable product according to the WEEE directive.



Pb

❑ NOTES ON USE

WARNINGS

- Avoid high temperatures.
Allow for sufficient heat dispersion when installed in a rack.
- Handle the power cord carefully.
Hold the plug when unplugging the cord.
- Keep the unit free from moisture, water, and dust.
- Unplug the power cord when not using the unit for long periods of time.
- Do not obstruct the ventilation holes.
- Do not let foreign objects into the unit.
- Do not let insecticides, benzene, and thinner come in contact with the unit.
- Never disassemble or modify the unit in any way.
- Ventilation should not be impeded by covering the ventilation openings with items, such as newspapers, tablecloths or curtains.
- Naked flame sources such as lighted candles should not be placed on the unit.
- Observe and follow local regulations regarding battery disposal.
- Do not expose the unit to dripping or splashing fluids.
- Do not place objects filled with liquids, such as vases, on the unit.
- Do not handle the mains cord with wet hands.
- When the switch is in the OFF (STANDBY) position, the equipment is not completely switched off from MAINS.
- The equipment shall be installed near the power supply so that the power supply is easily accessible.
- Do not keep the battery in a place exposed to direct sunlight or in places with extremely high temperatures, such as near a heater.

1. IMPORTANT NOTICE: DO NOT MODIFY THIS PRODUCT

This product, when installed as indicated in the instructions contained in this manual, meets R&TTE directive requirements. Modification of the product could result in hazardous Radio and EMC radiation.

2. CAUTION

- Separation distance of at least 20 cm must be maintained between the antenna of this product and all persons.
- This product and its antenna must not be co-located or operating in conjunction with any other antenna or transmitter.

❑ CAUTIONS ON INSTALLATION

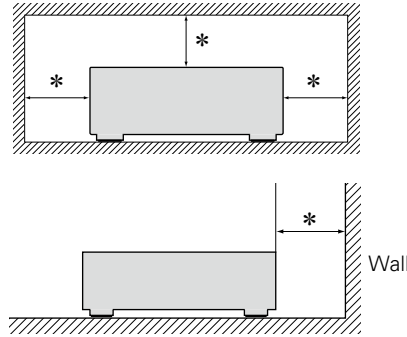

* **For proper heat dispersal, do not install this unit in a confined space, such as a bookcase or similar enclosure.**

- More than 0.1 m is recommended.
- Do not place any other equipment on this unit.

Getting started

Thank you for purchasing this DENON product. To ensure proper operation, please read these owner's manual carefully before using the product. After reading them, be sure to keep them for future reference.

Contents

Getting started	1
Accessories	2
Main features	2
Cautions on handling	2
Remote operation	3

Preparations

[5](#)

Connections	6
Connecting the amplifier	6
System connection with the DENON DRA-F109 receiver	7
Connecting to a home network (LAN)	8
Connecting the power cord	9
Setup	10
Menu map	10
Setting the first setup [Quick Setup]	11
Setting the general [General]	11
Setting the network [Network]	14

Operations

[19](#)

Operations	20
Preparations	20
Operations possible during playback	20
Network audio playback	21
Favorite function	25
iPod playback	26
USB memory device playback	28
AirPlay function	30
Remote play function	32
Other functions	33

Informations

[35](#)

Part names and functions	36
Front panel	36
Rear panel	36
Remote control unit	37
Other information	39
iPod	39
USB memory device	39
Network audio	40
Explanation terms	41
Troubleshooting	42
Specifications	45

Accessories

Check that the following parts are supplied with the product.

① Getting Started	1
② CD-ROM (Owner's manual)	1
③ Safety Instructions	1
④ Service network list.....	1
⑤ Remote control unit (RC-1164) (With battery)	1
⑥ Coaxial digital cable	1
⑦ System cable.....	1

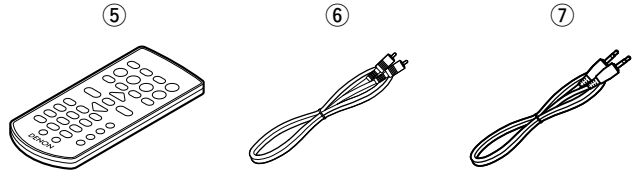

Main features

Equipped with the AirPlay® function in addition to network functions such as Internet Radio (👉 page 30)

DLNA ver. 1.5 supported for Audio Network

Internet radio by vTuner

Supports online music, Last.fm

“Denon Remote App” compatibility for performing basic unit operations with an iPhone®, iPod touch® or Android smartphone

Equipped with a USB port that is compatible with playback from iPhone and iPod® (👉 page 26)

Wi-Fi network capability with built-in diversity antenna including Wi-Fi Protected Setup (WPS)

Certified under WMM (Wi-Fi Multi-Media) for efficient wireless connectivity

**3 Lines OELD
(Organic Electroluminescence Display)**

Auto Standby mode for save the energy

Cautions on handling

• Before turning the power switch on

Check once again that all connections are correct and that there are no problems with the connection cables.

• Power is supplied to some of the circuitry even when the unit is set to the standby mode. When going on vacation or leaving home for long periods of time, be sure to unplug the power cord from the power outlet.

• About condensation

If there is a major difference in temperature between the inside of the unit and its surroundings, condensation may form on parts inside the unit, causing it to fail to operate properly.

If this happens, let the unit sit for an hour or two with the power turned off and wait until there is little difference in temperature before using the unit.

• Cautions on using mobile phones

Using a mobile phone near this unit may result in noise. If that occurs, move the mobile phone away from the unit when it is in use.

• Moving the unit

Turn off the power and unplug the power cord from the power outlet. Next, disconnect the cables connected to other system units before moving the unit.

• About care

- Wipe the cabinet and control panel clean with a soft cloth.
- Follow the instructions when using a chemical cleaner.
- Benzene, paint thinner or other organic solvents as well as insecticide may cause material changes and discoloration if brought into contact with the unit, and should therefore not be used.

Remote operation

About the remote control unit

Before Using

Remove the insulating sheet before using the remote control unit.

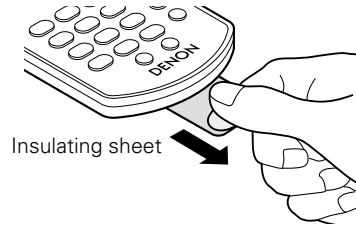

Inserting the batteries

① Remove the rear lid.

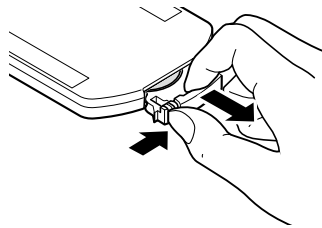

② Load the battery properly as indicated by the marks in the battery compartment.

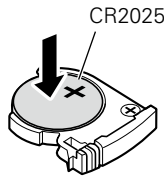

③ Put the rear lid back on.

NOTE

- Insert the specified battery in the remote control unit.
- Replace the battery with new ones if the set does not operate even when the remote control unit is operated close to the unit. (The supplied battery are only for verifying operation.)
- When inserting the battery, be sure to do so in the proper direction, following the ⊕ and ⊖ marks in the battery compartment.
- To prevent damage or leakage of battery fluid:
 - Do not short-circuit, disassemble, heat or dispose of batteries in flames.
 - Do not keep the battery in a place exposed to direct sunlight or in places with extremely high temperatures, such as near a heater.
- If the battery fluid should leak, carefully wipe the fluid off the inside of the battery compartment and insert new batteries.
- Remove the battery from the remote control unit if it will not be in use for long periods.
- Used battery should be disposed of in accordance with the local regulations regarding battery disposal.
- The remote control unit may function improperly if rechargeable battery are used.

Operating range of the remote control

Point the remote control unit at the remote sensor when operating it.

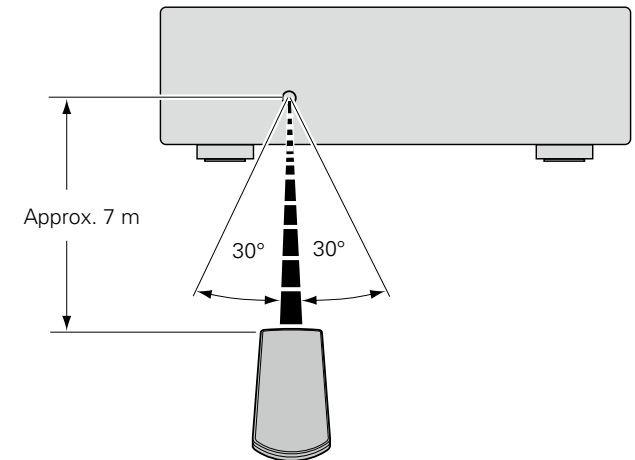

NOTE

- The set may function improperly or the remote control unit may not operate if the remote control sensor is exposed to direct sunlight, strong artificial light from an inverter type fluorescent lamp or infrared light.
- When using 3D video devices that transmit radio communication signals (such as infrared signals etc) between the various units (such as the monitor, 3D glasses, 3D transmitter unit etc), the remote control unit may not operate due to interference from those radio communication signals. If this occurs, adjust the direction and distance of the 3D communication for each unit, and check that the remote control unit operation is not affected by these signals.

Denon Remote App

Denon Remote App is a unique application developed for the iPhone, iPod touch and Android smartphone. This application enables you to control DENON network devices that are connected to your home network. Install the App onto your iPhone, iPod touch or Android smartphone to control this device.

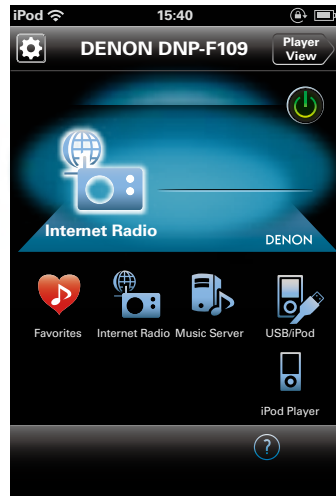

- Bidirectional communication is performed.
- The Denon Remote App can be downloaded for free from the iTunes® Store.

Preparations

Here, we explain the connections and basic operation methods for this unit.

- **Connections**  [page 6](#)
- **Setup**  [page 10](#)

Connections

For system connections, also see the section “System connection with the DENON DRA-F109 receiver” ([page 7](#)).

NOTE

- Do not plug in the power cord until all connections have been completed.
- When making connections, also refer to the owner’s manual of the other components.
- Be sure to connect the left and right channels properly (left with left, right with right).
- Do not bundle power supply cords together with connection cables. Doing so can result in humming or noise.

Cables used for connections

Select the cables according to the equipment being connected.

Audio cable (supplied)	
Coaxial digital cable	
System cable	
Audio cable (sold separately)	
Audio cable	

Connecting the amplifier

Analog connections

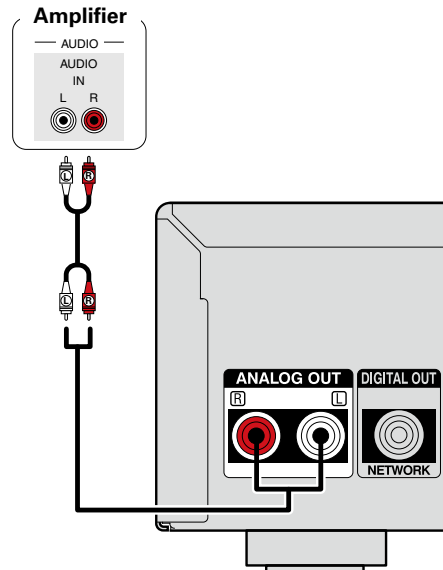

Digital connections

Connect digital devices such as AV receivers and D/A converters with the unit to enjoy digital audio output from the unit.

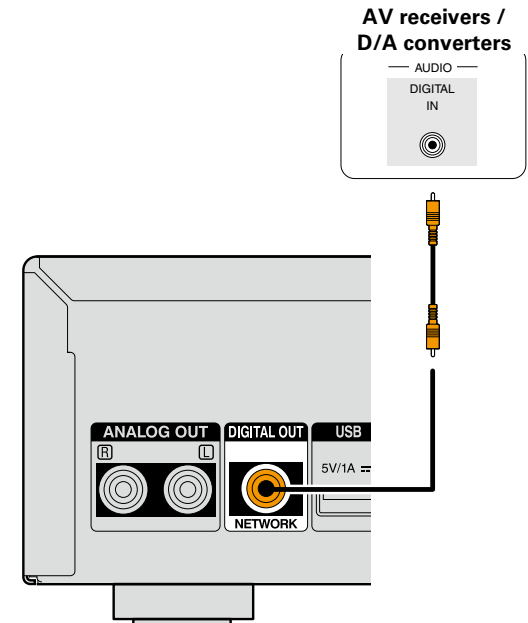

System connection with the DENON DRA-F109 receiver

By connecting this unit to the DENON DRA-F109 receiver with the supplied coaxial digital and system cables to make the system connection, you can perform operations on the F109 system with the DENON application on iPhone and iPod touch.

NOTE

- For the audio connection when making the system connection, make the digital audio connection. With the analog audio cable connection, some system operations do not work.
- For the system cable, connect IN and OUT as shown in the figure. If the connection is wrong, system operations do not work.
- The system connection of this unit is available only on DENON system audio F109 series devices. Do not make the system connection between devices other than F109 series.
- When connecting a DCD-F109 (CD player, sold separately), follow the connection method in the DRA-F109 (stereo receiver, sold separately) Owner's Manual.

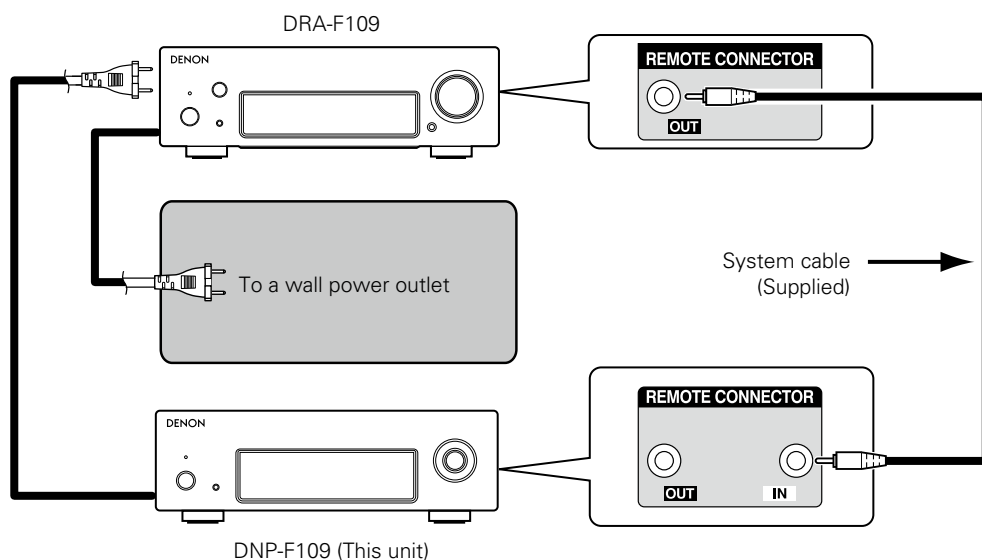

What can be done with this connection

Operations on this unit with the DRA-F109's system remote control

Auto power on function

When you press **▶/||**, **INTERNET RADIO**, **ONLINE MUSIC**, **MUSIC SERVER**, **iPod/USB (NETWORK)** or **FAVORITE CALL**, the corresponding device is turned on and the source automatically switches on DRA-F109 accordingly.

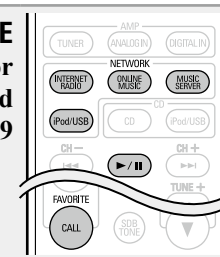

Alarm function

- Playback can be performed at a set time using the DRA-F109's alarm function.
- For details, see the owner's manual of the DRA-F109 (stereo receiver, sold separately).

Auto standby function

When you set the auto standby function to ON for either of DRA-F109 or DNP-F109, the auto standby function works on the entire F109 system.



For the auto standby function, see [page 11](#).

Connecting to a home network (LAN)

- This unit lets you play via your home network (LAN) music files stored on a computer and music content such as that from Internet radio and online services.
- You can update by downloading the latest firmware from the DENON website.
For more information, see "Update" ([page 12](#)).
- See "Setting the network [Network]" ([page 14](#)) for more information on network setting.

Wired LAN

Cables used for connections

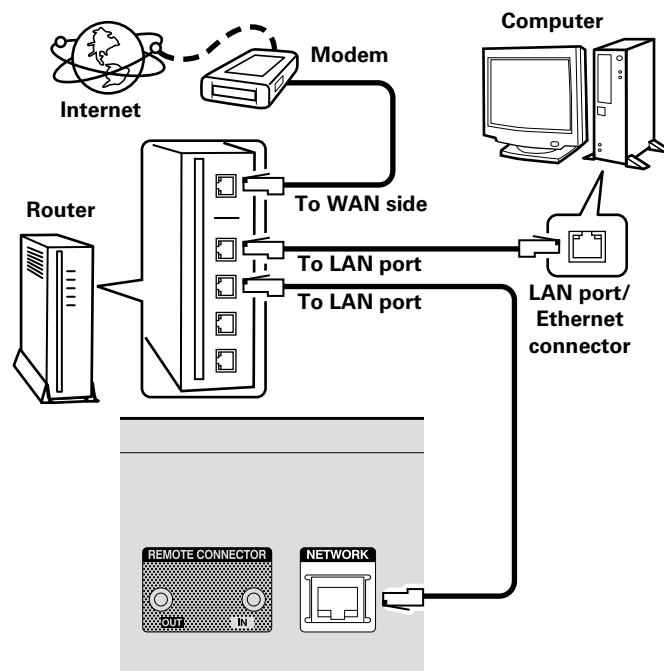
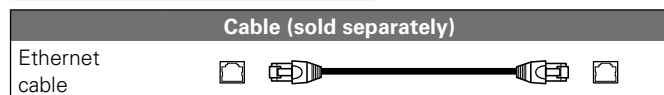

For connections to the Internet, contact an ISP (Internet Service Provider) or a computer shop.

Wireless LAN

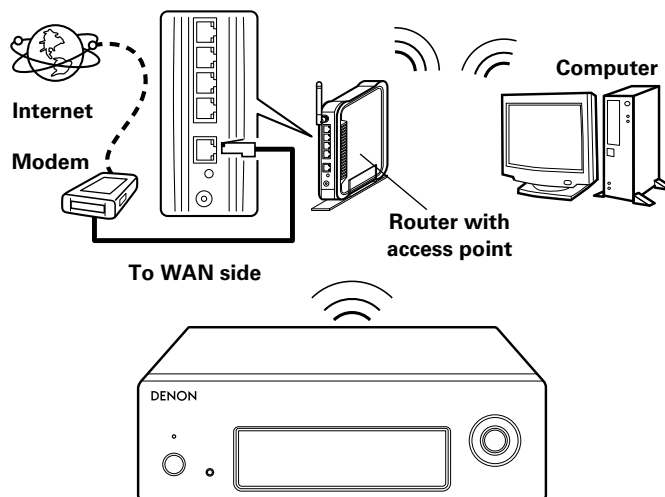

NOTE

If there is any obstacle, communications may be disrupted. If this happens, place the relevant devices in a place where there is no obstacle.

Required system

❑ Broadband internet connection

❑ Modem

Device that connects to the broadband circuit and conducts communications on the Internet.

A type that is integrated with a router is also available.

❑ Router

When using this unit, we recommend you use a router equipped with the following functions:

- Built-in DHCP server
This function automatically assigns IP addresses on the LAN.
- Built-in 100BASE-TX switch
When connecting multiple devices, we recommend a switching hub with a speed of 100 Mbps or greater.
- When using with a wireless LAN, prepare a broadband router with built-in access point ([page 16](#)).

❑ Ethernet cable (CAT-5 or greater recommended)

- Use only a shielded STP or ScTP LAN cable which is available at retailer.
- Some flat type Ethernet cables are easily affected by noise. We recommend using a normal type cable.



- If you have an Internet provider contract for a line on which network settings are made manually, make the settings at "Network connecting (when "DHCP" settings are "Off")" ([page 14](#)).
- With this unit, it is possible to use the DHCP and Auto IP functions to make the network settings automatically.
- When using this unit with the broadband router's DHCP function enabled, this unit automatically performs the IP address setting and other settings.
When using this unit connected to a network with no DHCP function, make the settings for the IP address, etc., at "Network connecting (when "DHCP" settings are "Off")" ([page 14](#)).
- When setting manually, check the setting contents with the network administrator.

NOTE

- A contract with an ISP is required to connect to the Internet.
- No additional contract is needed if you already have a broadband connection to the Internet.
- The types of routers that can be used depend on the ISP. Contact an ISP or a computer shop for details.
- DENON assumes no responsibility whatsoever for any communication errors or troubles resulting from customer's network environment or connected devices.
- This unit is not compatible with PPPoE. A PPPoE-compatible router is required if you have a contract for a type of line set by PPPoE.
- Do not connect an ETHERNET connector directly to the LAN port/Ethernet connector on your computer.
- To listen to audio streaming, use a router that supports audio streaming.

Connecting the power cord

When all of the connections are completed, insert the power plug into the power outlet.

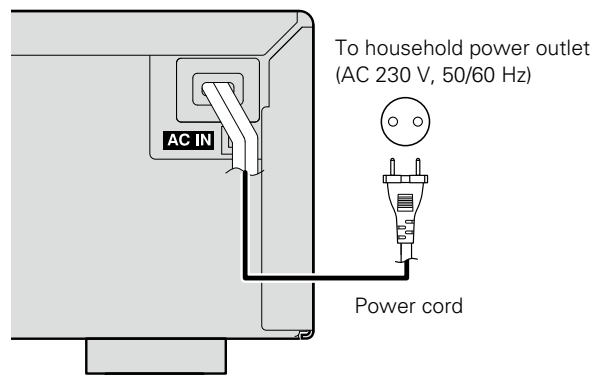





NOTE

- **Do not plug in the power cord until all connections have been completed.**
 - Do not bundle power cords together with connection cables. Doing so can result in humming or noise.
 - Insert the AC plugs securely. Incomplete connections could cause noise.
- Do not unplug the power cord before the power indicator turns off and the DNP-F109 enters Standby mode.

Setup

Menu map

Setting items	Detailed items	Description	Page		
Quick Setup 	Quick Setup	Performs the network settings using a Wizard style window. For details on the operations, see the separate "Getting Started".	-		
General 	Language	Sets the language.	11		
	Auto-Standby	Sets the unit power to standby when the unit is not in use.	11		
	Firmware	Update	Updates the firmware.	12	
		Notification	Set the Update and Upgrade notification on/off.	12	
		Add New Feature	Displays new functions that can be downloaded, and upgrades functions.	13	
Network 	Network Information	Displays various information about the network.	-		
	Network Control	Performs the ON/OFF settings for the network function when in standby mode.	18		
	Friendly Name	Edits a name displayed on the Internet.	18		
	Last.fm Display	Disables the display of Last.fm on the menu.	18		
	Settings		Performs the settings for a wired or wireless LAN.	14	
			Performs the settings for a wired LAN.	14	
		When making wired connection	DHCP (On) or DHCP (Off)	Performs the DHCP setting.	14
			IP Address*	Performs the IP address setting.	14
			Subnet Mask*	Performs the subnet mask setting.	14
			Gateway* 1	Performs the gateway setting.	14
			Wired Setup	Primary DNS*	Performs the primary DNS setting.
		Secondary DNS*		Performs the secondary DNS setting.	14
		Proxy		Performs the proxy setting.	15
		When making Wi-Fi connection	Test Connection	Performs the wired LAN connection.	14
				Performs the wireless LAN connection setting.	16
			Auto-Scan	Selects and sets the wireless connections from the access point list.	16
			WPS (Wi-Fi Protected Setup)	Sets the wireless connection using WPS (Wi-Fi Protected Setup).	16
	Manual	Sets the wireless connection manually.	17		

* Displayed when the "DHCP" setting ( [page 14](#)) is "Off".

Setting the first setup [Quick Setup]

- For details on “Quick Setup” operations, see the separate “Getting Started”.
- If you cancelled “Quick Setup” menu or changed the network environment, perform “Setup” – “Quick Setup”.

Setting the general [General]

Language

Sets the language for display the menu.

- The factory language setting is “English”.

1 Press **SETUP**.

Turns on the Menu settings mode and the Menu appears on the display ([page 10](#) “Menu map”).

2 Use Δ ∇ and **ENTER** to select “General” – “Language”, then press **ENTER** or \triangleright .

English / Deutsch / Français /
Italiano / Nederlands / Español /
Svenska

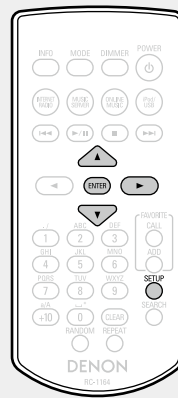

Auto-Standby

With the Auto-Standby ON, this unit will automatically enter the standby mode after about 30 continuous minutes of stop mode with no operation.

- The default setting is “On”.

1 Press **SETUP**.

Turns on the Menu settings mode and the Menu appears on the display ([page 10](#) “Menu map”).

2 Use Δ ∇ and **ENTER** to select “General” – “Auto-Standby”, then press **ENTER** or \triangleright . “Select Auto-Standby” menu appears.

3 Use Δ ∇ to select “On”, then press **ENTER** or \triangleright . The setting is entered.

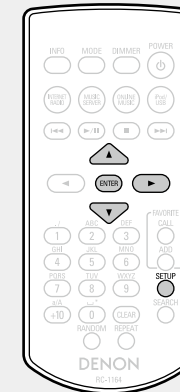

NOTE

In the following situations, the Auto-standby function does not operate.

- When the input source being played is “Internet Radio”, “iPod/USB” (Remote mode) or “AirPlay”.

Firmware

Update

- In order to update the firmware, the environment and settings required for connecting to broadband internet are needed (page 8).
- Perform the firmware update operation after at least 2 minutes has elapsed since turning this unit's power ON.

1 Press SETUP.

Turns on the Menu settings mode and the Menu appears on the display (page 10 "Menu map").

2 Use Δ / ∇ and ENTER to select "General" – "Firmware" – "Update", then press ENTER or \triangleright .

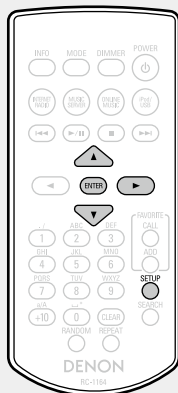

Check For Update

Check for firmware updates. You can also check approximately how long it will take to complete an update.

Update Start

Execute the update process.

- If updating fails, the set automatically retries, but if updating is still not possible, one of the messages shown below is displayed. If the display reads as shown below, check the settings and network environment, then update again.

Display	Description
Updating fail	Updating failed.
Login failed	Failure to login to server.
Server is busy	Server is busy. Wait a while then try again.
Connection fail	Failure in connecting to server.
Download fail	Downloading of the firmware has failed.

Notification

Update

Displays a notification message on this unit's menu screen when the latest firmware is released with "Update".

Connect to broadband Internet (page 8) when using this function.

1 Press SETUP.

Turns on the Menu settings mode and the Menu appears on the display (page 10 "Menu map").

2 Use Δ / ∇ to select "General" – "Firmware" – "Notification" – "Update", then press ENTER or \triangleright .

"Update Notification" menu appears.

3 Use Δ / ∇ to select "On", then press ENTER or \triangleright .

On Display update message.

Off Do not display update message.

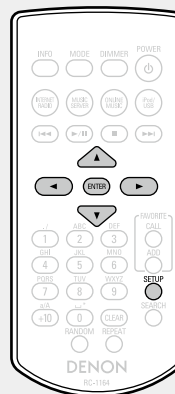

- When you press **ENTER** during display of the notification message, the "Check for Update" is displayed. (Refer to page 13 for more information on "Update".)
- Press \triangleleft to erase the notification message.

Upgrade

Display a notification message on this unit's menu screen when downloadable firmware is released with "Add New Feature". Connect to broadband Internet (page 8) when using this function.

1 Press SETUP.

Turns on the Menu settings mode and the Menu appears on the display (page 10 "Menu map").

2 Use Δ / ∇ to select "General" – "Firmware" – "Notification" – "Upgrade", then press ENTER or \triangleright .

"Upgrade Notification" menu appears.

3 Use Δ / ∇ to select "On", then press ENTER or \triangleright .

On Display upgrade message.

Off Do not display upgrade message.

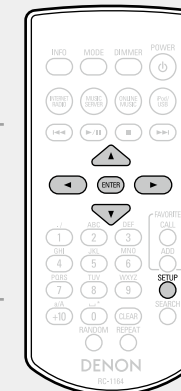

- When you press **ENTER** during display of the notification message, the "Add New Feature" is displayed. (Refer to page 13 for more information on "Add New Feature".)
- Press \triangleleft to erase the notification message.

❑ Add New Feature

- In order to add new functions, the environment and settings required for connecting to broadband internet are needed ([page 8](#)).
- Perform the add new feature operation after at least 2 minutes has elapsed since turning this unit's power on.

1 Press SETUP.

Turns on the Menu settings mode and the Menu appears on the display ([page 10](#) "Menu map").

2 Use Δ / ∇ to select "General" – "Firmware" – "Add New Feature", then press ENTER or \triangleright .

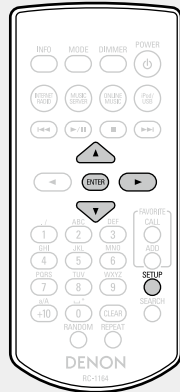

Upgrade Status Display a list of the additional functions provided by the upgrade.

Upgrade Start Execute the upgrade process.

- If the upgrade is not successful, an error message identical to those in "Update" ([page 12](#)) will appear on the display. Check the settings and network environment, then update again.

Upgrade ID The ID number shown on this screen is needed when carrying out the procedure.



See the DENON website for details about updates.

When the procedure is complete, "Registered" is displayed and updates can be carried out. If the procedure has not been carried out, "Not Registered" is displayed.

[Notes concerning use of "Update" and "Add New Feature"]

- Do not turn off the power until updating or upgrading is completed.
- Even with a broadband connection to the Internet, approximately 20 minutes is required for the updating/upgrading procedure to be completed.
- Once updating/upgrade starts, normal operations on this unit cannot be performed until updating/upgrading is completed.
- Furthermore, updating/upgrading the firmware may reset the backup data for the parameters, etc. set for this unit.
- If the update or upgrade fails, remove and re-insert the power cord. "Update Retry" appears on the display and update restarts from the point at which update failed. If the error continues despite this, check the network environment.



- Information regarding the "Update" function and "Add New Feature" will be announced on the DENON web site each time related plans are defined.
- When usable new firmware is released with "Update" or "Add New Feature", a notification message is displayed on the menu screen. When you do not want to be notified, set "Notification" – "Update" ([page 12](#)) and "Notification" – "Upgrade" ([page 12](#)) to "Off".

Setting the network [Network]

Connecting wired LAN

Use this procedure to configure the wired LAN settings.

□ Network connecting (when “DHCP” settings are “On”)

When using this unit with the broadband router’s DHCP function enabled, this unit automatically performs the IP address setting and other settings.

1 Connect the ETHERNET cable (page 8 “Connecting to a home network (LAN)” – “Wired LAN”).

2 Press **POWER**  to turn on power to the main unit.

3 Press **SETUP**.
Turns on the Menu settings mode and the Menu appears on the display (page 10 “Menu map”).

4 Use Δ / ∇ and **ENTER** to select “Network” – “Settings” – “DHCP (On)”, then press **ENTER** or \triangleright .
“Select DHCP” menu appears.

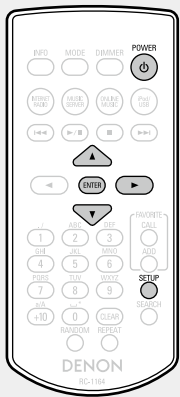

5 Use Δ / ∇ to select “On”, then press **ENTER** or \triangleright .
“DHCP (On)” menu appears.

6 Use Δ / ∇ to select “Test Connection”, then press **ENTER** or \triangleright .
“Wait for the network to connect...” is displayed, and the unit starts connecting to the LAN.

- When the connection is made successfully, “Connected!” appears.
- If the connection cannot be established, “Connection Failed” is displayed. Perform steps 1 – 6 again.



You may need to set the network connection manually, depending on the provider you use. To set the connection manually, use the setting procedure of “Network connecting (when “DHCP” settings are “Off”)”.

□ Network connecting (when “DHCP” settings are “Off”)

This section explains the settings when connecting this unit to a network that does not have a DHCP function.



To configure the settings manually, check the setting details with your network administrator.

1 Perform steps 1 – 4 of the “Network connecting (when “DHCP” settings are “On”)” procedure and select “Off” in step 5.
“DHCP (Off)” menu appears.

2 Use Δ / ∇ to select “IP Address”, then press **ENTER** or \triangleright .
“Enter IP Address” menu appears.

3 Use Δ / ∇ / \triangleright or **0 – 9** to input the IP address and press **ENTER**.

4 Use Δ / ∇ / \triangleright or **0 – 9** to input the address for “Subnet Mask”, “Gateway”, “Primary DNS”, and “Secondary DNS”.

5 Use Δ / ∇ to select “Test Connection”, then press **ENTER** or \triangleright .
“Wait for the network to connect...” is displayed, and the unit starts connecting to the LAN.

- When the connection is made successfully, “Connected!” appears.
- If the connection cannot be established, “Connection Failed” is displayed. Perform steps 1 – 4 again.

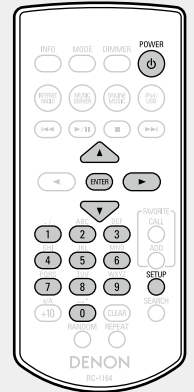

Proxy settings

Configure these settings to connect to the internet via a proxy server.

1 Press SETUP.

Turns on the Menu settings mode and the Menu appears on the display (see [page 10](#) "Menu map").

2 Use Δ / ∇ and ENTER to select "Network" – "Settings" – "Proxy", then press ENTER or \triangleright .

"Setup Proxy" menu appears.

3 If "Proxy(On)" appears, go to step 5.

If "Proxy(Off)" appears, press ENTER or \triangleright .

"Select Proxy" menu appears.

4 Use Δ / ∇ to select "On", then press ENTER or \triangleright .

"Setup Proxy" menu appears.

5 Use Δ / ∇ to select "Proxy (Address)" or "Proxy (Name)", then press ENTER or \triangleright .

"Select Type" menu appears.

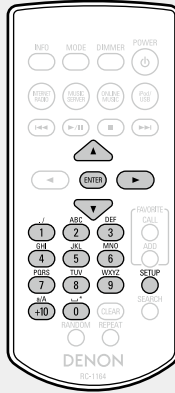
**6 Use Δ / ∇ to select "Address" or "Name", then press ENTER or \triangleright .**

"Setup Proxy" menu appears.

7 Use Δ / ∇ to select "Address" or "Name", then press ENTER or \triangleright .

"Enter Proxy Address" or "Enter Proxy Name" menu appears.

8 Use Δ / ∇ \triangleright or 0 – 9, +10 to input the address or name, then press ENTER.

"Setup Proxy" menu appears.

9 Use Δ / ∇ to select "Port", then press ENTER or \triangleright .

"Enter Proxy Port" menu appears.

10 Use Δ / ∇ \triangleright or 0 – 9 to input the port, then press ENTER.

The Proxy settings are completed.

Connecting wireless LAN

Use this procedure to configure the wireless LAN settings.

❑ Auto-Scan (Wireless LAN)

If a LAN cable is connected, remove it.

1 Press POWER  to turn on power to the main unit.

2 Press SETUP.

Turns on the menu settings mode and the menu appears on the display ([page 10](#) "Menu map").

3 Use Δ / ∇ and ENTER to select "Network" – "Settings" – "Auto-Scan", then press ENTER or \triangleright .

The access point you have set is displayed.

4 Use Δ / ∇ to select the access point, and then press ENTER or \triangleright .

• If the access point is not detected automatically, configure it manually ([page 17](#) "Manual Settings").

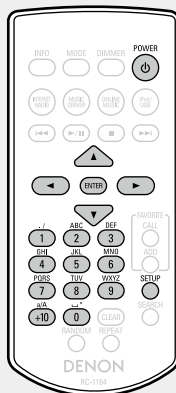

5 If there is an encryption setting for the access point you selected in step 4, enter same encryption key as used for the access point.

Use Δ / ∇ / \triangleleft / \triangleright or **0–9, +10** to input the "Password" (encryption key) and press **ENTER** or \triangleright . Enter the same encryption key as used for the access point.

• The types of characters that can be input are as shown below.

[Lower case characters]

abcdefghijklmnopqrstuvwxyz

[Upper case characters]

ABCDEFGHIJKLMNOPQRSTUVWXYZ

[Symbols] ! " # \$ % & ' () * + , - . / : ; < = > ? @ [\] ^ _ ` { | } ~

[Numbers] 0123456789 (Space)

• When no security settings have been used in the Internet connection settings, this step is not necessary.

❑ WPS Settings (Push-button method)

1 Press SETUP.

Turns on the Menu settings mode and the Menu appears on the display ([page 10](#) "Menu map").

2 Use Δ / ∇ and ENTER to select "Network" – "Settings" – "WPS (Wi-Fi Protected Setup)" – "Push Button", then press ENTER or \triangleright .

3 Press the WPS button of the router.

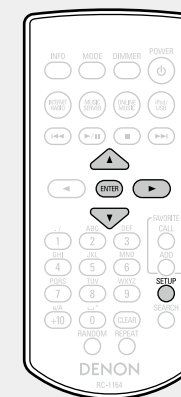

- When connection is established with access point, "Connected!" is displayed.
- If the connection cannot be established, "Connection Failed" is displayed. Perform steps 2 – 3 again.

NOTE

If the router uses WEP, WPA-TKIP or WPA2-TKIP encryption, connection is not possible using the WPS setup. In this case, connect using "Auto-Scan" or "Manual".

□ WPS Settings (PIN code method)

1 Press SETUP.

Turns on the Menu settings mode and the Menu appears on the display (page 10 "Menu map").

2 Use Δ / ∇ and ENTER to select "Network" – "Settings" – "WPS" – "PIN code", then press ENTER or \triangleright .

The access point you have set is displayed.

3 Use Δ / ∇ to select the access point whose PIN code you want to display, and press ENTER or \triangleright .

PIN code number is displayed.

4 Set this PIN code to the register.

When connection is established with access point, "Connected!" is displayed.

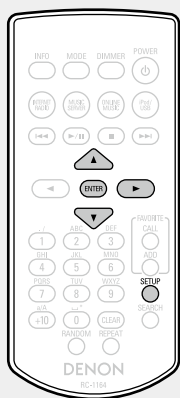

□ Manual Settings

1 Press SETUP.

Turns on the Menu settings mode and the Menu appears on the display (page 10 "Menu map").

2 Use Δ / ∇ and ENTER to select "Network" – "Settings" – "Manual", then press ENTER or \triangleright .

3 Use Δ / ∇ to select "SSID", then press ENTER or \triangleright .

4 Use Δ / ∇ / \triangleleft / \triangleright or 0 – 9, +10 to input the name of the wireless network (SSID), then press ENTER.

- The types of characters that can be input are as shown below.

[Lower case characters]

abcdefghijklmnopqrstuvwxyz

[Upper case characters]

ABCDEFGHIJKLMNOPQRSTUVWXYZ

[Symbols] ! " # \$ % & ' () * + , - . / : ; < = > ? @ [\] ^ _ ` { | } ~

[Numbers] 0123456789 (Space)

5 Use Δ / ∇ to select "Security", then press ENTER or \triangleright .

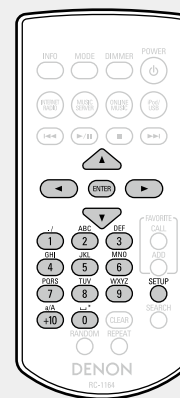

6 Use Δ / ∇ to select following items, then press ENTER or \triangleright .

None Select if not encrypted. Can also be used even without encryption, through we recommend encryption for improved security.

WEP / WPA-PSK(TKIP) / WPA-PSK(AES) / WPA2-PSK(TKIP) / WPA2-PSK(AES)

Select the encryption method according to the encryption setting of the access point you are using.

7 Use Δ / ∇ to select "Password", then press ENTER.

8 Use Δ / ∇ / \triangleleft / \triangleright to enter the encryption key, and press ENTER.

Enter the same encryption key as used for the access point.

- When no security settings have been used in the Internet connection settings, this step is not necessary.
- When connecting to a "WEP" encrypted network, set the access point "Default Key" to "1".

9 Use ∇ to select "Test Connection" and press ENTER or \triangleright .

"Wait for the network to connect..." is displayed, and the unit starts connecting to the network.

- This unit performs automatic network setup due to the DHCP function.

NOTE

This unit is not compatible with WEP (TSN) encryption system.

Other network settings

Network Control

Set the network function On/Off during standby.

1 Press **SETUP**.

Turns on the Menu settings mode and the Menu appears on the display (see page 10 "Menu map").

2 Use Δ / ∇ to select "Network" – "Network Control", then press **ENTER** or \triangleright .

"Network Control" menu appears.

3 Use Δ / ∇ to select "On", then press **ENTER** or \triangleright .

On Network is on during standby. Main unit operable with a network compatible controller. Shortens the time before the network connection is completed.

- When "Network Control" is set to "On", the power display lights red.
- More power is consumed when in standby (Power consumption: 6 W).

Off Suspend network function during standby. It will take slightly longer till the network connection is completed.

- The minimum amount of power is consumed when in standby (Power consumption: 0.2 W).
- This is the default setting.

4 Press **SETUP**.

The display returns to normal.

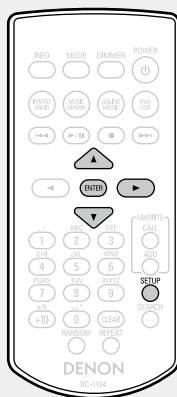

Friendly Name

The Friendly Name is the name of this unit displayed on the network (Maximum 63 characters).

1 Press **SETUP**.

Turns on the Menu settings mode and the Menu appears on the display (see page 10 "Menu map").

2 Use Δ / ∇ to select "Network" – "Friendly Name", then press **ENTER** or \triangleright .

"Friendly Name" menu appears.

3 Select the friendly name (DENON DNP-F109), and press **ENTER**.

4 Edit a friendly name.

- For character input, see page 33.

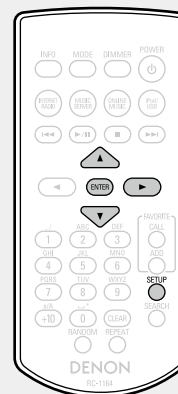

Resetting the friendly name to the default setting

In step 3, select "Default" and press **ENTER**.

Last.fm Display

Set whether or not to display Last.fm item on the menu.

1 Press **SETUP**.

Turns on the Menu settings mode and the Menu appears on the display (see page 10 "Menu map").

2 Use Δ / ∇ to select "Network" – "Last.fm Display", then press **ENTER** or \triangleright .

"Last.fm Display" appears.

3 Use Δ / ∇ to select "Show" or "Hide", then press **ENTER** or \triangleright .





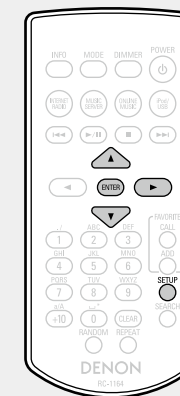



Show Last.fm items will be displayed.

Hide Last.fm items will not be displayed.



Operations

Here, we explain functions and operations that let you make better use of this unit.

- Preparations  [page 20](#)
- Operations possible during playback  [page 20](#)
- Network audio playback  [page 21](#)
- Favorite function  [page 25](#)
- iPod playback  [page 26](#)
- USB memory device playback  [page 28](#)
- AirPlay function  [page 30](#)
- Remote play function  [page 32](#)
- Other functions  [page 33](#)

Operations

This section provides information on operations of playback procedures.

Preparations

Turning the power on

Press **POWER** .

The power indicator lights green and the power turns on.



- When you turn on the power of this unit for the first time after purchasing it, the “Quick Setup” menu starts up. For details on “Quick Setup” operations, see the separate “Getting Started”.
- If you cancelled “Quick Setup” menu or changed the network environment, perform “Setup” – “Quick Setup”.

Turning the power to standby mode

Press **POWER** .

The unit enters standby mode.

- Power indicator
 - Standby : Off
 - Network Control – “On” : Red
 - iPod charge standby : Red



NOTE

Power continues to be supplied to some of the circuitry even when the power is in the standby mode. When leaving home for long periods of time, unplug the power cord from the power outlet.

Completely turning off the power

Unplug the power cord from the wall outlet.

Operations possible during playback

Selecting the input source

Selecting the input source using the main unit

- 1 Press SOURCE.**
The display changes to the input source selection screen.
- 2 Press Δ / ∇ to select the input source, then press \blacktriangleright /|| ENTER or \blacktriangleright .**
The input source is switched each time the button is pressed.

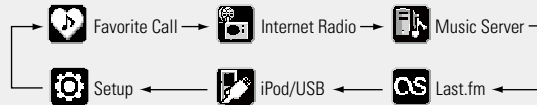

With the unit, you can play back music files stored on your iPhone/iPod touch and music from iTunes ([see page 30](#) “AirPlay function”).

Selecting the input source using the remote control

Press the input source select button (**INTERNET RADIO, MUSIC SERVER, ONLINE MUSIC or iPod/USB**).

The desired input source can be selected directly.

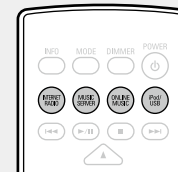

Switching the display's brightness

Press **DIMMER**.

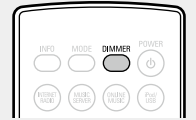

- The display brightness is adjusted each time **DIMMER** is pressed as shown below.

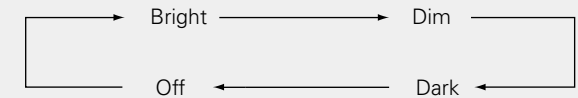

If you operate the buttons when the display's brightness is set to “Off”, the display temporarily lights at “Dark” brightness level.

Network audio playback

Follow this procedure to play Internet radio stations or music files stored on a computer.

- ❑ **About the internet radio function** ([page 40](#))
- ❑ **About Music server** ([page 40](#))
- ❑ **About Last.fm** ([page 40](#))

Listening to internet radio

1 Prepare for playback.

- ① Check the network environment, then turn on this unit's power ([page 20](#) "Turning the power on").
- ② If settings are required, make the "Setting the network [Network]" ([page 14](#)).

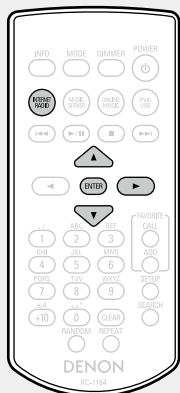

2 Press INTERNET RADIO to switch the input source to "Internet Radio".

- For details on selecting the input source using the unit buttons, see "Selecting the input source using the main unit" ([page 20](#)).

3 Press $\Delta \nabla$ to select the item you want to play, then press ENTER or \triangleright .

4 Repeat step 3 until the station list is displayed.

The station list is displayed.

- Any characters that cannot be displayed are replaced with "." (period) or " " (space).

5 Press $\Delta \nabla$ to select the station, then press ENTER or \triangleright .

Playback starts once buffering reaches "100%".



- There are many Internet radio stations on the Internet, and the quality of the programs they broadcast as well as the bit rate of the tracks varies widely. Generally, the higher the bit rate, the higher the sound quality, but depending on the communication lines and server traffic, the music or audio signals being streamed may be interrupted. Inversely, lower bit rates mean a lower sound quality but less tendency for the sound to be interrupted.
- "Server Full" or "Connection Down" is displayed if the station is busy or not broadcasting.

❑ Switching the display

Press INFO during Internet radio reception.

The broadcast station information and signal format bit rate are displayed.



❑ Recently played internet radio stations

Recently played internet radio stations can be selected from "Recently Played".

Up to 20 stations stored in "Recently Played".

1 On a top menu of the internet radio station, press $\Delta \nabla$ to select "Recently Played", then press ENTER or \triangleright .

2 Press $\Delta \nabla$ to select the item you want to play, then press ENTER or \triangleright .

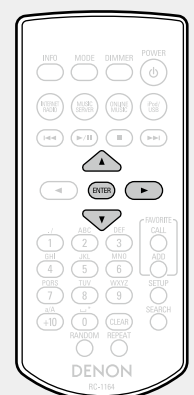

❑ Searching stations by keyword (Alphabetic strings)

1 Press $\Delta \nabla$ to select "Search by Keyword", then press ENTER or \triangleright .

2 Use $\Delta \nabla \triangleright$ or NUMBER (0 – 9, +10) to input the characters, then press ENTER.

- For character input, see [page 33](#).

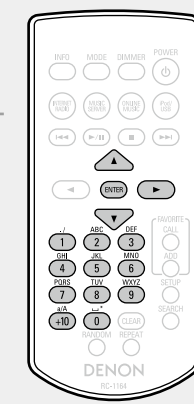

❑ Registering internet radio stations as your favorites

You can register your favorite broadcast stations in Favorite List ([page 25](#)).

❑ Internet radio operation

Operation buttons	Function
FAVORITE ADD	Registration to the Favorite list
FAVORITE CALL	Call from the Favorite list
■, ▶/ *1	Stop
SETUP	Menu
$\Delta \nabla \triangleleft \triangleright$	Cursor operation (Up/Down/Left/Right)
ENTER	Enter
SEARCH	Character search*2

*1 **▶/||** only on the front panel can be used.

*2 Press **SEARCH**, then press **ENTER** to select the first letter you want to search mode.



If the list is not in alphabetical order, you may not be able to perform a character search.

Applying media sharing settings

Here, we apply the settings to share music files stored on a PC and NAS on the network.

Sharing media stored in PC

If you are using a media server, be sure to apply this setting first.

When using Windows Media Player 12 (Windows 7)

NOTE

Perform this procedure after changing the control panel display to "Category".

- 1** In the PC's "Control Panel", select "Network and Internet" – "Choose homegroup and sharing options".
- 2** Select the "Stream my pictures, music, and videos to all devices on my home network" check box and select "Choose media streaming options".
- 3** Select "Allowed" in the drop-down list for "DENON DNP-F109".
- 4** Select "Allowed" in the drop-down list for "Media programs on this PC and remote connections...".
- 5** Click "OK" to finish.

When using Windows Media Player 11

- 1** Start up Windows Media Player 11 on the PC.
- 2** Select "Media Sharing" in the "Library".
- 3** Click the "Share my media" check box, select "DENON DNP-F109", and then click "Allow".
- 4** As you did in step 3, select the icon of the device (other PCs and mobile devices) you want to use as a media controller, and then click "Allow".
- 5** Click "OK" to finish.

Sharing media stored in NAS

Change settings on the NAS to allow this unit and other devices (PCs and mobile devices) used as media controllers to access the NAS. For details, see the owner's manual that came with the NAS.

Playing files stored on a PC and NAS

Use this procedure to play music files or playlists.

1 Prepare for playback.

- ① Check the network environment, then turn on this unit's power ([page 20](#) "Turning the power on").
- ② If settings are required, make the "Setting the network [Network]" ([page 14](#)).
- ③ Prepare the computer ([page 22](#) "Applying media sharing settings", [page 40](#) "About Music server").

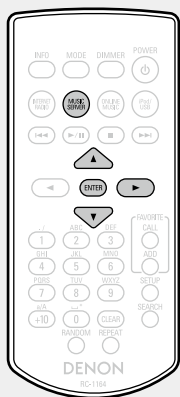

2 Press **MUSIC SERVER** to switch the input source to "Music Server".

- For details on selecting the input source using the unit buttons, see "Selecting the input source using the main unit" ([page 20](#)).

3 Press $\Delta \nabla$ to select the server including the file to be played, then press **ENTER** or \triangleright .

4 Press $\Delta \nabla$ to select the search item or folder, then press **ENTER** or \triangleright .

5 Repeat step 4 until the file is displayed.

6 Press $\Delta \nabla$ to select the file, then press **ENTER** or \triangleright . Playback starts once buffering reaches "100%".



- Connections to the required system and specific settings must be made in order to play music files ([page 8](#)).
- Before starting, you must launch the computer's server software and set the files as server contents. For details, see the operating instructions of your server software.
- The order in which the tracks/files are displayed depends on the server specifications. If the tracks/files are not displayed in alphabetical order due to the server specifications, searching by the first letter may not work properly.
- WMA Lossless files can be played when using a server supporting transcoding, such as Windows Media Player Ver. 11 or later.

NOTE

Particularly when you play back large music files, depending on your wireless LAN environment, the playback sound may be interrupted. In this case, make the wired LAN connection.

Playing repeatedly (Repeat playback)

([page 28](#))

Playing random order (Random playback)

([page 28](#))

Switching the display

During playback, Press **INFO**.

- The display switches each time **INFO** is pressed.

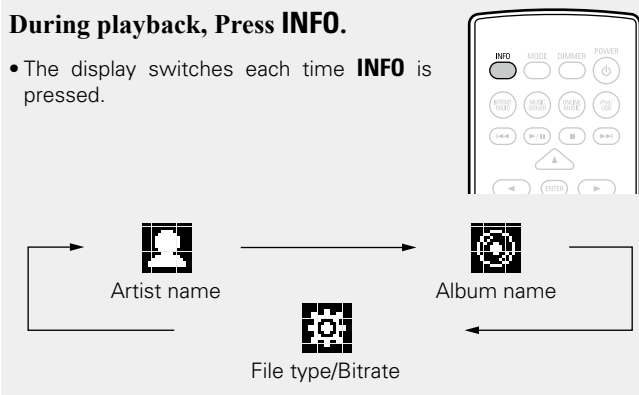

Music server operation

Operation buttons	Function
FAVORITE ADD	Registration to the Favorite list
FAVORITE CALL	Call from the Favorite list
$\ll \gg$	Auto search (cue)
$\triangleright / \parallel$	Playback / Pause
\blacksquare	Stop
SETUP	Menu
$\Delta \nabla \triangleleft \triangleright$	Cursor operation ($\Delta \nabla \triangleleft \triangleright$) / Auto search (cue, $\Delta \nabla$)
ENTER	Enter
SEARCH	Character search*1
REPEAT	Repeat playback (page 28)
RANDOM	Random playback (page 28)*2

*1 Press **SEARCH**, then press **ENTER** to select the first letter you want to search mode.

*2 When playing files stored on a computer using the random play function, when a track has finished playing, the next track is selected at random from all of the tracks on the computer. For this reason, the same track may be played back to back.



- If the list is not in alphabetical order, you may not be able to perform a character search.
- Depending on the server being used, some functions may be limited.

Listening to Last.fm

Last.fm radio is not available in all countries. Please check www.last.fm/hardware for more information. You'll also need a subscription. Get one today at www.last.fm/subscribe.

1 Prepare for playback.

- ① Make sure this unit is connected to the Internet, then turn on this unit's power (see page 20 "Turning the power on").
- ② If settings are required, make the "Setting the network [Network]" (see page 14).

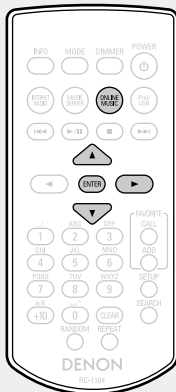

2 Press **ONLINE MUSIC** to switch the input source to "Last.fm".

- For details on selecting the input source using the unit buttons, see "Selecting the input source using the main unit" (see page 20).
- If you do not have a Last.fm account, press **▽** to select "I am new to Last.fm". Then press **ENTER** or **▷**. Create an account in accordance with the instructions on the display.

3 If you have a Last.fm account, press **△▽** to select "I have a Last.fm account". Then press **ENTER** or **▷**.

4 Use **△▽▷** to enter your username and password.

- For character input, see page 33.

5 After inputting the username and password, select "login", then press **ENTER**.

If the username and password match, the top menu for Last.fm is displayed.

- The types of characters that can be input are as shown below.

- Username**
[Lower case characters] abcdefghijklmnopqrstuvwxyz
[Upper case characters] ABCDEFGHIJKLMNOPQRSTUVWXYZ
[Symbols] _ -
[Numbers] 0123456789
- Password**
[Lower case characters] abcdefghijklmnopqrstuvwxyz
[Upper case characters] ABCDEFGHIJKLMNOPQRSTUVWXYZ
[Symbols] ! " # \$ % & ' () * + , - . / : ; < = > ? @ [\] ^ _ ` { | } ~ (Space)
[Numbers] 0123456789

6 Use **△▽** to select menu and then press **ENTER** or **▷**.

- Popular Tags** Play popular tags in your area.
- Popular Artists** Play popular artists tags in your area.
- Your Recent Stations** Play your recent stations.
- Your Recommended Radio** Play your recommended radio.
- Your Library** Play your library.
- Your Friend's Radio** Play your friend's radio.
- Your Top Artists** Play your top Artists.
- Search Tag Radio** You can search station by Tag.
- Search Artist Radio** You can search station by Artist.

7 Use **△▽** to select a station, and press **ENTER**, **▷** or **▶/||** to start playback.

Playback starts.

8 When you press **▷** during playback, the following menu appears.

- Love this track** Loving tracks improves your Last.fm recommendations, and you can optionally share them on popular social networks.
- Ban this track** If you ban a track, we won't play it again. You can undo this on the Last.fm website.
- Scrobbling** Scrobbling sends the tracks you played to your Last.fm account. You can see charts of the music you've been listening to, get recommendations for new music and events in your area and share your listening tastes with your friends. You can turn this service on or off using this option. The more you scrobble, the better your recommendations will become.

NOTE

The password should be no longer than 90 characters

Switching the display

During playback, Press **INFO**.

The file type/bit rate, artist name and album name are displayed.

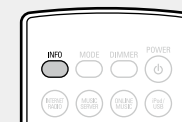

Last.fm operation

Operation buttons	Function
▶/ 	Playback
▶▶ 	Auto search (cue)
■ or ▶/ ENTER (main unit)	Stop
SETUP	Menu
△▽◁▷	Cursor operation / Auto search (cue, ▽)
ENTER	Enter



Favorite function

This section provides information on the Favorite function.

- The Favorite function allows you to register your favorite broadcast stations and files in Favorite List in advance so that you can call and listen to the stations or files right away, whenever you want.
- The contents that you can register and call are Internet radio station and music server.
- You can register up to 50 items in Favorite List.

Registering stations or files to the favorites list

- 1 Press FAVORITE ADD while the Internet radio station or file to register is played back.**
“Favorite” menu appears.

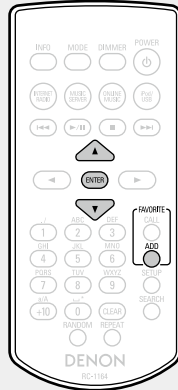

- 2 Press Δ / ∇ to select a number to register the station or file, and press ENTER.**
“Add to Favorite” is displayed and the registration is completed.

Calling stations or files from the favorites list

- 1 Press FAVORITE CALL.**
The Favorite list appears.
- 2 Press \lll \ggg or Δ / ∇ to select the station or file that you want to call, and press ENTER.**
The respective function starts up and playback starts.

- Press **0–9, +10** to call files registered to the Favorite list by number.

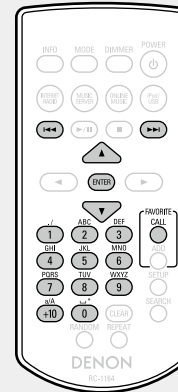

- To switch between registered stations and files during playback**
Press \lll \ggg or Δ / ∇ .

Deleting stations or files from the favorite list

- 1 Press FAVORITE CALL.**
The Favorite list appears.
- 2 Press Δ / ∇ to select the station or file that you want to delete, and press CLEAR.**
- 3 When the prompt “Delete?” appears, press ENTER.**
“Deleted” is displayed and the deletion is completed.

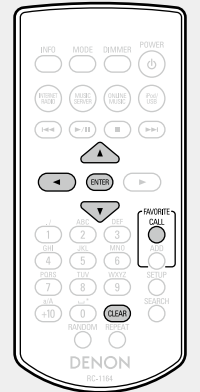

- To cancel the operation**
Press \triangleleft .

iPod playback

You can use the USB cable provided with the iPod to connect the iPod with the unit's USB port and enjoy music stored on the iPod. The unit can play back music stored on iPod/iPod touch/iPod classic/iPod nano and iPhone.

□ iPod (page 39)

Playing an iPod

1 Connect the iPod to the USB port using the USB cable that was supplied with the iPod.

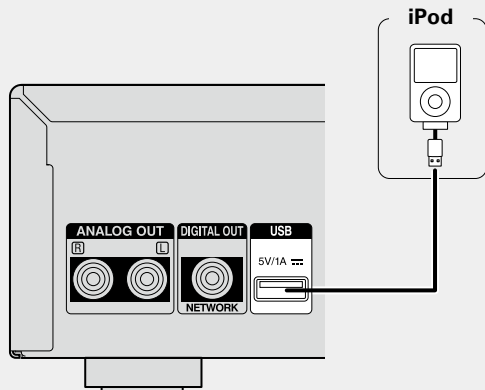

2 Press **POWER** to turn on power to the main unit.

3 Press **iPod/USB** to switch the input source to "iPod/USB".

• For details on selecting the input source using the unit buttons, see "Selecting the input source using the main unit" (page 20).

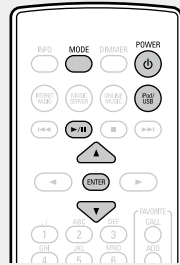

4 Press **MODE** to select the display mode.

The display mode switches each time **MODE** is pressed.

- There are two modes for displaying the contents recorded on the iPod.

Browse mode Display iPod information on the display of this unit.

Remote mode Display iPod information on the iPod screen.

- "Remote iPod" is displayed on the display of this unit.

	Display mode	Browse mode	Remote mode
Display location		Main unit display	iPod display
Playable files	Audio file	✓	✓
	Video file		✓*
Active buttons	Remote control and main unit	✓	✓
	iPod		✓

* Only audio is played back.

- The default display mode setting is "Remote mode".

5 Use Δ / ∇ to select the item, then press **ENTER** to select the music file to be played.

6 Press **▶/||**. Playback starts.

NOTE

- DENON will accept no responsibility whatsoever for any loss of iPod data.
- Depending on the type of iPod and the software version, some functions may not operate.
- When connecting an iPhone to this unit, keep the iPhone at least 20 cm away from this unit. If the iPhone is kept closer to this unit and a telephone call is received by the iPhone, noise may be output from this device.

Remote control and iPod button relations

Remote control buttons	iPod buttons	Operation on this unit
⏮, ⏭	⏮, ⏭	Play the track from the beginning/Play the next track
▶/	▶/	Play the track / Pause the track
⏮, ⏭ (Press and hold)	⏮, ⏭ (Press and hold)	Fast-reverse the track/Fast-forward the track
■	—	Stop the track
MODE	—	Switch between the browse mode and the remote mode
Δ / ∇	Click Wheel	Cursor operation (up/down)
◀	MENU	Display the menu or return to the previous menu
ENTER or ▶	Select	Enter the selection or plays the track
REPEAT	—	Switch the repeat function
RANDOM	—	Switch the shuffle function

Switching the display

During playback, Press **INFO**.

- The display switches each time **INFO** is pressed (Browse mode only).



Artist name



Album name

Playing repeatedly (Repeat playback)

(page 28)

(Browse mode only)

Playing random order (Random playback)

(page 28)

Disconnecting the iPod

1 Press **POWER**  to set the standby mode.

2 Disconnect the iPod from the USB port.



Supported iPod models

• iPod classic



iPod classic
80GB



iPod classic
160GB (2007)



iPod classic
160GB (2009)

• iPod nano



iPod nano
3rd generation
(video)
4GB 8GB



iPod nano
4th generation (video)
8GB 16GB



iPod nano
5th generation (video camera)
8GB 16GB



iPod nano
6th generation
8GB 16GB

• iPod touch



iPod touch
1st generation
8GB 16GB 32GB



iPod touch
2nd generation
8GB 16GB 32GB



iPod touch
3rd generation
32GB 64GB



iPod touch
4th generation
8GB 32GB 64GB

• iPhone



iPhone
4GB 8GB 16GB



iPhone 3G
8GB 16GB



iPhone 3GS
8GB 16GB 32GB



iPhone 4
8GB 16GB 32GB



iPhone 4S
16GB 32GB 64GB

(as of June 2012)

Charging the iPod

You can charge your iPhone/iPod by connecting it to the USB port.

☐ Standby charging

If the unit enters power standby mode while the iPod/iPhone is charging, the unit will switch to standby charging mode, and the iPod/iPhone will continue to be charged. When in standby charging mode, the power display light turns red.

When the iPhone/iPod is fully charged, the unit automatically stops supplying power for charging and enters standby mode.

USB memory device playback

You can playback music stored on a USB memory device using this unit.

□ **USB memory device** (👉 [page 39](#))

Playing files stored on USB memory devices

1 Connect the USB memory device to the USB port.

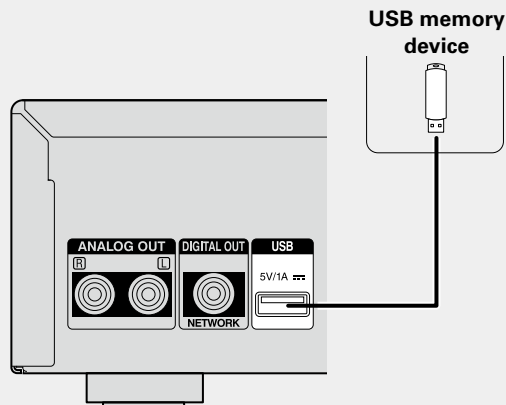

2 Press **POWER** to turn on power to the main unit.

3 Press **iPod/USB** to switch the input source to “iPod/USB”.

• For details on selecting the input source using the unit buttons, see “Selecting the input source using the main unit” (👉 [page 20](#)).

4 Press Δ/∇ to select the file or folder, then press **ENTER** or \triangleright .

5 Press Δ/∇ to select the file, then press **ENTER**, \triangleright or $\blacktriangleright/\text{II}$. Playback starts.

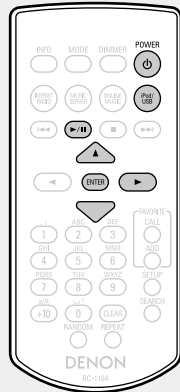

- If the USB memory device is divided into multiple partitions, only the top partition can be selected.
- This unit is compatible with MP3 files conforming to “MPEG-1 Audio Layer-3” standards.
- DENON does not guarantee that all USB memory devices will operate or receive power. When using a portable USB connection type HDD of the kind to which an AC adapter can be connected to supply power, use the AC adapter.

NOTE

- USB memory devices will not work via a USB hub.
- It is not possible to connect and use a computer via the USB port of this unit using a USB cable.
- Do not use an extension cable when connecting a USB memory device. This may cause radio interference with other devices.
- Note that DENON will accept no responsibility whatsoever for any problems arising with the data on a USB memory device when using this unit in conjunction with the USB memory device.

Removing the USB memory device

1 Press **POWER** to set the standby mode.

2 Check that the communication indicator on the USB memory device is not flashing, then pull out the USB memory device.

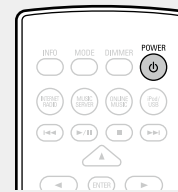

NOTE

Do not remove the USB memory device from the unit when the USB memory communication indicator is flashing. Doing so may damage the USB memory device, or may corrupt the files recorded on the USB memory device.

Playing repeatedly (Repeat playback)

Press **REPEAT**.

Repeat playback starts.

- Each time you press **REPEAT**, the repeat mode is toggled as shown below.

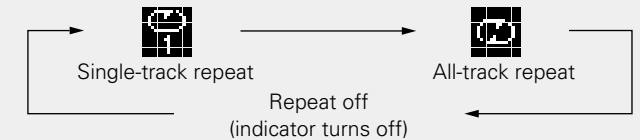

	(Single-track repeat)	Only 1 track plays repeatedly.
	(All-track repeat)	All tracks within the current playback folder are repeated.
	Repeat off (indicator turns off)	Normal playback resumes.

Playing random order (Random playback)

Press **RANDOM**.

The indicator lights in the display, and random playback starts.



□ **Canceling random playback**

Press **RANDOM**.

The indicator on the display turns off.

□ USB operation

Operation buttons	Function
◀◀, ▶▶	Auto search (cue)
▶/	Playback / Pause
■	Stop
△▽	Cursor operation / Auto search (cue, △▽)
ENTER or ▷	Enter / Playback
◀	Display the menu or return to the previous menu
SEARCH	Character search*1
REPEAT	Repeat playback
RANDOM	Random playback*2

*1 Press **SEARCH**, then press **ENTER** to select the first letter you want to search mode.

*2 When playing files stored on a USB memory device using the random play function, when a track has finished playing, the next track is selected at random from all of the tracks on the device. For this reason, the same track may be played back to back.



If the list is not in alphabetical order, you may not be able to perform a character search.

□ Switching the display

During playback, Press **INFO**.

- The display switches each time **INFO** is pressed.

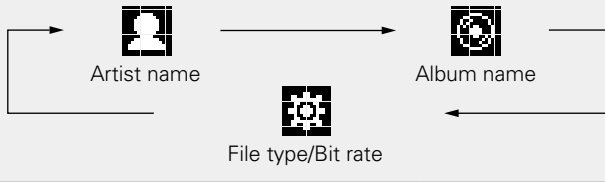

AirPlay function

Enjoy music from your iTunes library with DENON quality sound anywhere in your home.

Streaming music stored in iPhone or iPod touch directly to the unit

If you update your "iPhone/iPod touch" to iOS 4.2.1 or later, you can stream music stored in your "iPhone/iPod touch" directly to this unit.

- 1 **Start the music mode on the iPhone or iPod touch.**
 is displayed on the iPhone or iPod touch screen.

- 2 **Tap the AirPlay icon .**
Set "Network Control" ([page 18](#)) to "On" for this unit.

NOTE

When "Network Control" is set to "On", the unit consumes more standby power.

- 3 **Select the speaker you want to use.**

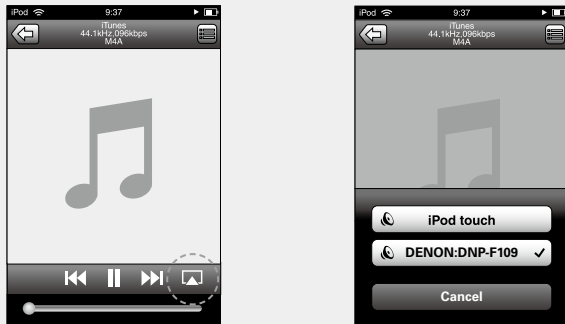

NOTE

Sound volume control using the volume control bar on an iPhone or iPod touch is available only when this unit is operated in DRA-F109 system connection. If connected to an amplifier other than DRA-F109, sound volume cannot be controlled by an iPhone or iPod touch.

Playing iTunes music on this unit

- 1 **Install iTunes 10, or later, on a Mac or PC that is connected to the same network as this unit.**

- 2 **Turn this unit ON.**
Set "Network Control" ([page 18](#)) to "On" for this unit.

NOTE

When "Network Control" is set to "On", the unit consumes more standby power.

- 3 **Launch iTunes and click the AirPlay icon  displayed in the lower right of the window and select this unit from the list.**

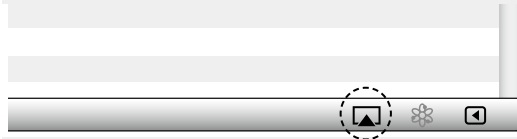

- 4 **Choose a song and click play in iTunes.**
The music will stream to this unit.

Multiple speakers (for DRA-F109 system connection only)

You can easily stream music from iTunes to multiple speakers in your home.

- 1 **Click the AirPlay icon  and select "Multiple Speakers" from the list.**

- 2 **Check the speakers you want to use.**

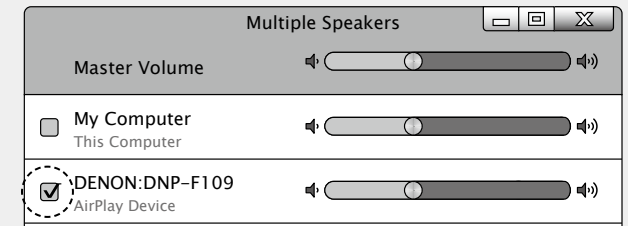

Remote operations

You can use your DENON remote control to play and pause iTunes, as well as skip to next and previous tracks.

1 Open “Edit” – “Preferences” in iTunes, and click “Devices”.

2 Check “Allow iTunes audio control from remote speakers”.

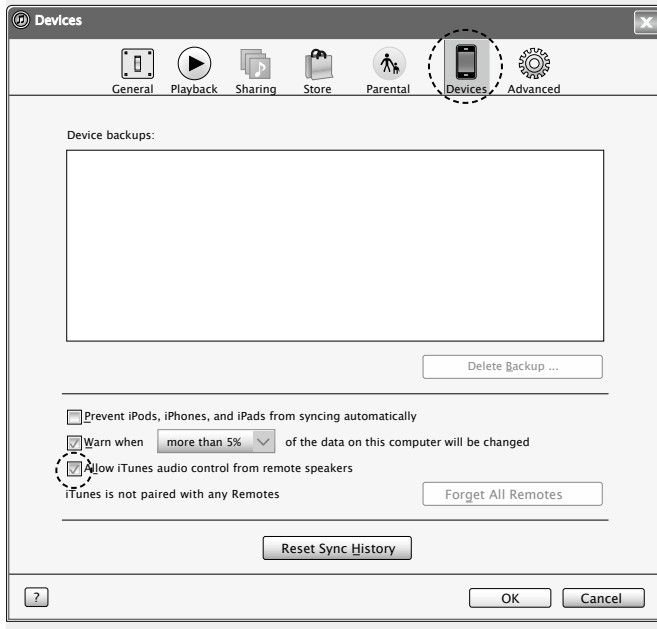

- Source input will be switched to “AirPlay” when AirPlay playback is started.
- You can stop AirPlay playback by pressing the ◀ or choosing other input source.
- To see artist name or album name together, press the **INFO**.
- For information about how to use iTunes, also see the Help for iTunes.
- The screen may differ depending on the OS and software versions.
- When you connect iPod to the USB connector during AirPlay playback, AirPlay playback stops.



Remote play function

You can use your home network to play back with this unit music files stored on PC, NAS, mobile phones and portable audio players. In this case, you use PC, mobile phones and portable audio players for operations.



- The relevant devices should comply with the DLNA (Digital Living Network Alliance) Ver. 1.5 standard.
- A wireless LAN environment is required for playing back music files on mobile phones or portable audio players.
- For some mobile phones, you must install an application for DLNA music playback.

Roles each device plays

The following devices are used for Remote Play. As specified in the DLNA standard, these devices are called DMC, DMS or DMR according to their role.

Name	Device example	Role
DMC (Digital Media Controller)	<ul style="list-style-type: none"> • PC • Mobile phone • Portable audio player 	Performs Remote Play operations. DMC can also play back music files stored on these devices.
DMS (Digital Media Server)	<ul style="list-style-type: none"> • PC • NAS (Network Attached Storage) 	Stores music files. Music files stored on these devices are played back with DMC.
DMR (Digital Media Renderer)	<ul style="list-style-type: none"> • This unit 	Outputs audio of music files played back through Remote Play from speakers. DMR cannot perform playback operations.

Files that can be played back

See “Important information” – “About Music server” ([page 40](#)).

Settings required for each device

You must make settings on DMC and DMS for Remote Play. Make the following settings. Also see the owner’s manual of each device for settings.

Settings on PC and NAS

Make settings on PC and NAS to exchange data with DMR devices. For settings, see “Applying media sharing settings” ([page 22](#)).

Settings on mobile phones

You must install an application for DLNA music playback on your mobile phone to perform operations on DMS and this unit (DMR) with your mobile phone. The applicable application differs according to your mobile phone.



Some mobile phones support DLNA music playback with the factory settings. See the owner’s manual of your mobile phone.

Settings on portable audio players

Make settings so that this unit (DMR) can play back music files stored on your portable audio player. For settings, see the owner’s manual of your portable player.

Settings on this unit

Connect this unit to the DLNA network. You do not need to make other settings. For the network connection, see the provided Getting Started, “Connecting to a home network (LAN)” ([page 8](#)) and “Setting the network [Network]” ([page 14](#)).

Remote Play operations

Operations are different for each device, but the procedures for preparing for Remote Play are the same. The preparation procedures are shown below.

- Turn on this unit.**
 - Make sure that this unit is connected to the network.
- Display the music file playback screen on DMC.**
 - For PC, open Windows Media Player 12, etc.
 - For mobile phones, switch to the music file playback mode.
- Select the friendly name of this unit for the item that sets the playback device on the playback screen.**
 - The default friendly name of this unit is “DENON DNP-F109”.
- Start playing back a music file on DMC.**
 - The function on this unit automatically switches to Music Server and the Remote Play mark () appears on the display. Remote Play starts.

NOTE

During Remote Play, you cannot perform playback operations with this unit. Use the DMC device for these operations.

To exit Remote Play

- Press .
- The Remote Play mode ends.



Other functions

Inputting characters

On this unit, the names displayed for "Friendly Name" and search screens can be changed as desired.

For inputting characters, there are two methods, as shown below.

Method	Operations
Using the number buttons	<ul style="list-style-type: none"> Operating with the remote control unit. Multiple characters are assigned to a button, and each time the button is pressed, a character is switched.
Using the cursor buttons	<ul style="list-style-type: none"> Operating with the remote control unit or the main unit. Use $\Delta \nabla \triangleleft \triangleright$ and ENTER to input characters.

□ Display of an input screen

[Friendly name input]

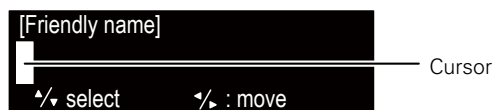

Using the number buttons

1 Display the screen for inputting characters.

2 Place the cursor at the character to be changed with $\triangleleft \triangleright$ and press **0 – 9** until the desired character is displayed.

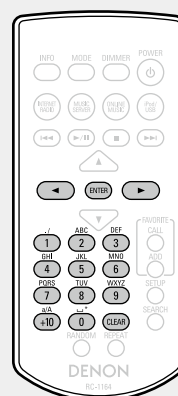

• The types of characters that can be input are as shown below.

1 $\cdot /$	1. @ - _ / : ~	6 mno	m n o M N O 6
2 abc	a b c A B C 2	7 $pqrs$	p q r s P Q R S 7
3 def	d e f D E F 3	8 $tuvw$	t u v T U V 8
4 ghi	g h i G H I 4	9 $wxyz$	w x y z W X Y Z 9
5 jkl	j k l J K L 5	0 \cdot	0 (Space) ! " # \$ % & ' () * + , ; < = > ? [\] ^ ` { }

- The input character type can be switched by pressing **+10** while the display name is being changed.
- Press **CLEAR** to delete the character.
- For entering the characters assigned to one number button continuously, press \triangleright to move the cursor to the right after entering a character then enter the next character.
- For entering characters assigned to separate buttons, press the number button continuously. The cursor automatically moves to the next position, and the entered character is registered.

3 Repeat step 2 to change the name then press **ENTER** to register it.

Example: For changing characters from "POPS" to "ROCK"

- ① Place the cursor at "P". ▶ POPS
- ② Press **7** seven times. ▶ ROPS
"P" changes to "R".
- ③ Press \triangleright twice. ▶ RO PS
"R" is automatically registered, and the cursor placed "P".
- ④ Press **2** six times. ▶ ROCS
"P" changes to "C".
- ⑤ Press \triangleright . ▶ ROCS
"C" is registered and the cursor placed "S".
- ⑥ Press **5** five times. ▶ ROCK
"S" changes to "K".
- ⑦ Press **ENTER** to register the input name.

Using the cursor buttons

- 1** Display the screen for inputting characters.
- 2** Use ◀ ▶ to set the cursor to the character you want to change.
- 3** Use ▲ ▼ to change the character.

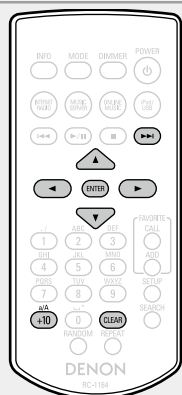

- The types of characters that can be input are as shown below.

[Lower case characters]

abcdefghijklmnopqrstuvwxyz

[Upper case characters]

ABCDEFGHIJKLMNOPQRSTUVWXYZ

[Symbols] ! " # \$ % & ' () * + , - . / : ; < = > ? @ [\] ^ _ ` { | } ~

[Numbers] 0 1 2 3 4 5 6 7 8 9 (Space)

- The input character type can be switched by pressing **+10** while the display name is being changed.
- Press **CLEAR** to delete the character.
- Press **▶▶I** to insert a space.

- 4** Repeat steps 2 and 3 to change the name then press **ENTER** to register it.

Auto power on function

When you press **INTERNET RADIO**, **MUSIC SERVER**, **ONLINE MUSIC**, **iPod/USB**, **▶/II** or **FAVORITE CALL**, the corresponding device is turned on and the source automatically switches.

- When you press **▶/II**, the previously selected source is played back.

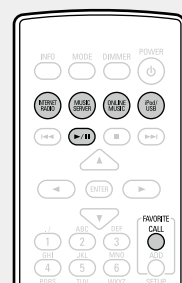

Last function memory

This stores the settings as they were immediately before going into the standby mode.

When the power is turned back on, the settings are restored to as they were immediately before going into the standby mode.

Resetting the microprocessor

Perform this procedure if the display is abnormal or if operations cannot be performed.

When the microprocessor is reset, all the settings are reset to their default values.









- 1** Pull the power cord out of the power outlet.
- 2** Plug the power cord into a power outlet while pressing **SOURCE** and **▶/II ENTER** simultaneously.
- 3** When the power indicator lights green, release the buttons.
"Initialized" appears in the display.



If "Initialized" does not display in step 3, start over from step 1.

Informations

Here, we list various information related to this unit.
Please refer to this information as needed.

- Part names and functions  [page 36](#)
- Other information  [page 39](#)
- Explanation terms  [page 41](#)
- Troubleshooting  [page 42](#)
- Specifications  [page 45](#)
- Index  [page 46](#)

Part names and functions

For buttons not explained here, see the page indicated in parentheses ().

Front panel

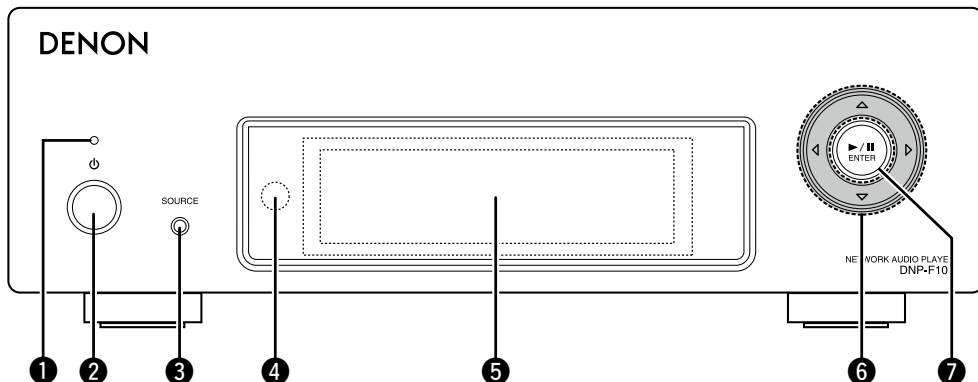

- 1 Power indicator** (20)
The power indicator changes as shown below according to the status of the unit.
 - Power on : Green
 - Standby : Off
 - Network Control – “On” : Red
 - iPod charge standby : Red
- 2 Power operation button (⏻)** (20)
Turns power to this unit on and off (standby).
- 3 Input source select button (SOURCE)** (20)
Selects the input source.
- 4 Remote control sensor** (3)
- 5 Display**
Displays play status, settings, etc.
- 6 Cursor button (⏮⏪⏩⏭)** (20)
- 7 Play/Pause button (▶/⏸)** (20)
ENTER button (20)

Rear panel

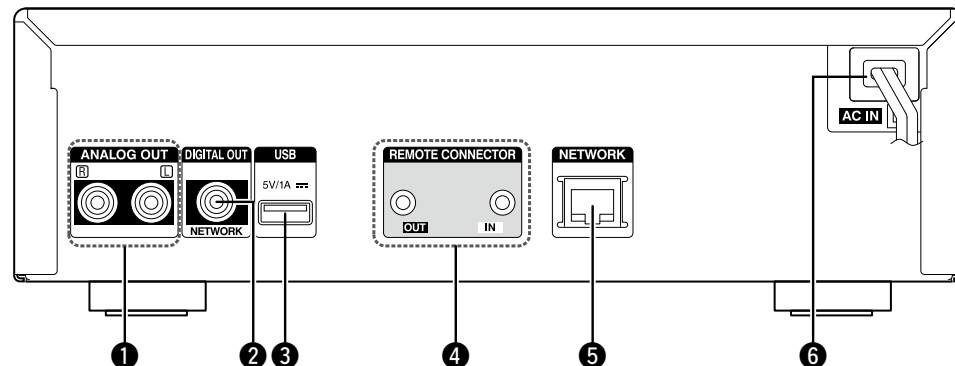

- 1 ANALOG OUT connectors** (6)
Connect a commercially available amp.
- 2 DIGITAL OUT connector** (6)
Connect a digital device such as a commercially available AV receiver or D/A converter.
- 3 USB port** (26, 28)
Used to connect iPod or USB memory devices.
- 4 REMOTE CONNECTOR jacks** (7)
- 5 ETHERNET connector** (8)
- 6 AC cord (AC IN)** (9)

Remote control unit

This section explains the buttons used to playback each input source.

Buttons that work with all input sources

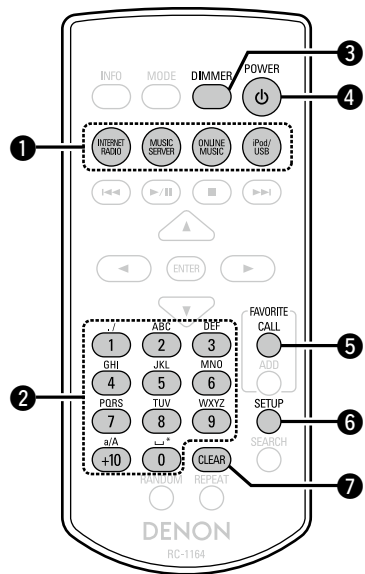

- 1 Input source select button (20)
- 2 Number buttons (0 – 9,+10)..... (25, 33)
- 3 DIMMER button (20)
- 4 POWER button (⏻) (20)
- 5 FAVORITE CALL button (25)
- 6 SETUP button (11, 14)
- 7 CLEAR button (33, 34)

Buttons that work when the input source is “Internet Radio”, “Music Server” or “Last.fm”

“Buttons that work with all input sources” can also be used.

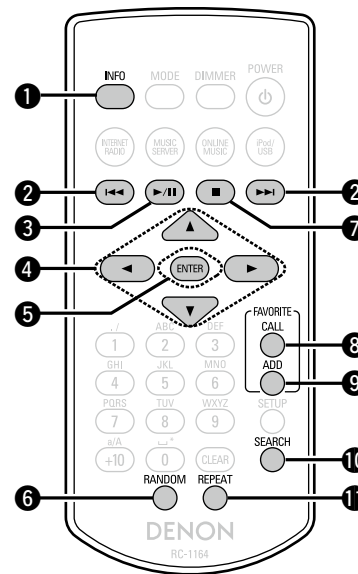

- 1 INFO button (21, 23)
 (“Internet Radio” and “Music Server” only)
- 2 Reverse-skip/Forward-skip buttons (⏮, ⏭) (23, 24)
 (“Music Server” and “Last.fm” only)
- 3 Play/Pause button (▶/⏸) (23, 24)
 (“Music Server” and “Last.fm” only)
- 4 Cursor buttons (⏪, ⏩, ⏴, ⏵) (21, 23, 24)
- 5 ENTER button (21, 23, 24)
- 6 RANDOM button (23)
 (“Music Server” only)
- 7 Stop button (■) (21, 23, 24)
- 8 FAVORITE CALL button (21, 23, 25)
- 9 FAVORITE ADD button (21, 23, 25)
 (“Internet Radio” and “Music Server” only)
- 10 SEARCH button (21, 23)
 (“Internet Radio” and “Music Server” only)
- 11 REPEAT button (23)
 (“Music Server” only)

Buttons that work when the input source is "iPod/USB"

"Buttons that work with all input sources" can also be used.

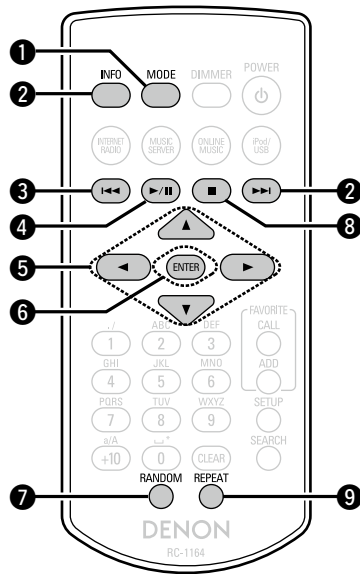

- 1** MODE button (26)
("iPod" only)
- 2** INFO button (26, 28)
- 3** Reverse-skip/Forward-skip buttons
(◀◀, ▶▶) (26, 28)
- 4** Play/Pause button (▶/||) (26, 28)
- 5** ENTER button (26, 28)
- 6** Cursor buttons (▲▼◀▶) (26, 28)
- 7** RANDOM button (26, 28)
- 8** Stop button (■) (26, 28)
- 9** REPEAT button (26, 28)

Other information

iPod



“Made for iPod” and “Made for iPhone” mean that an electronic accessory has been designed to connect specifically to iPod, or iPhone, respectively, and has been certified by the developer to meet Apple performance standards.

Apple is not responsible for the operation of this device or its compliance with safety and regulatory standards. Please note that the use of this accessory with iPod, or iPhone, may affect wireless performance.

AirPlay, the AirPlay logo, iPhone, iPod, iPod classic, iPod nano, iPod shuffle, and iPod touch are trademarks of Apple Inc., registered in the U.S. and other countries.

- Individual users are permitted to use iPhone, iPod, iPod classic, iPod nano, iPod shuffle, and iPod touch for private copy and playback of non-copyrighted contents and contents whose copy and playback is permitted by law. Copyright infringement is prohibited by law.

USB memory device

Important information

A USB memory device can be connected to the USB port of this unit to play music files stored on the USB memory device.

Also, files stored on an iPod can be played when the iPod is connected directly to the USB port of this unit. See “iPod playback” (page 26).

- Only USB memory devices conforming to mass storage class and MTP (Media Transfer Protocol) standards can be played on this unit.
- This unit is compatible with USB memory devices in “FAT16” or “FAT32” format.



If the number of files stored in a USB memory device exceeds 1,000, the access speed may become slower.

[Types of files that can be played back by each function]

	USB memory devices *1
WMA (Windows Media Audio)	✓ *2
MP3 (MPEG-1 Audio Layer-3)	✓
WAV	✓
MPEG-4 AAC	✓ *3
FLAC (Free Lossless Audio Codec)	✓

*1 USB

- This unit is compatible with MP3 ID3-Tag (Ver. 2) standard.
- This unit is compatible with WMA META tags.
- If the image size (pixels) of an album artwork exceeds 500×500 (WMA/MP3/WAV/FLAC) or 349×349 (MPEG-4 AAC), then music may not be played back properly.

*2 Copyright-protected files can be played on certain portable players compatible with MTP.

*3 Only files that are not protected by copyright can be played on this unit.

Content downloaded from pay sites on the Internet are copyright protected. Also, files encoded in WMA format when ripped from a CD, etc. on a computer may be copyright protected, depending on the computer’s settings.

[Playback file specifications]

	Sampling frequency	Bit rate	Bit length	Extension
WMA (Windows Media Audio)	32/44.1/48 kHz	48 – 192 kbps	–	.wma
MP3 (MPEG-1 Audio Layer-3)	32/44.1/48 kHz	32 – 320 kbps	–	.mp3
WAV	32/44.1/48 88.2/96/ 176.4/192 kHz	–	16 / 24 bit	.wav
MPEG-4 AAC	32/44.1/48 kHz	16 – 320 kbps	–	.aac/ .m4a/ .mp4
FLAC (Free Lossless Audio Codec)	32/44.1/48/ 88.2/96/ 176.4/192 kHz	–	16 / 24 bit	.flac

Important information

□ About the internet radio function

- Internet radio refers to radio broadcasts distributed over the Internet. Internet radio stations from around the world can be received.
- This unit is equipped with the following Internet radio functions:
 - Stations can be selected by genre and region.
 - Internet radio stations in MP3 and WMA (Windows Media Audio) format can be listened to.
- Your favorite radio stations can be registered by accessing an exclusive DENON Internet radio URL from a Web browser on a computer.
- The function is managed for individual users, so you must provide your MAC or e-mail address. Exclusive URL: <http://www.radiodenon.com>
- The radio station database service may be suspended without notice.
- This unit's Internet radio station list is created using a radio station database service (vTuner). This database service provides a list edited and created for this unit.

□ About Music server

This function lets you play music files and playlists (m3u, wpl) stored on a computer (music server) connected to this unit via a network.

With this unit's network audio playback function, connection to the server is possible using one of the technologies below.

- Windows Media Player Network Sharing Service
- Windows Media DRM10

[Types of files that can be played back by each function]

	Internet radio	Music server *1
WMA (Windows Media Audio)	✓	✓
MP3 (MPEG-1 Audio Layer-3)	✓	✓
WAV		✓
MPEG-4 AAC		✓*2
FLAC (Free Lossless Audio Codec)		✓

A server or server software compatible with distribution in the corresponding formats is required to play music files via a network.

*1 Music server

- This unit is compatible with MP3 ID3-Tag (Ver. 2) standard.
- This unit is compatible with WMA META tags.
- If the image size (pixels) of an album artwork exceeds 500×500 (WMA/MP3/WAV/FLAC) or 349×349 (MPEG-4 AAC), then music may not be played back properly.

*2 Only files that are not protected by copyright can be played on this unit.

Content downloaded from pay sites on the Internet are copyright protected. Also, files encoded in WMA format when ripped from a CD, etc. on a computer may be copyright protected, depending on the computer's settings.

[Playback file specifications]

	Sampling frequency	Bit rate	Bit length	Extension
WMA (Windows Media Audio)	32/44.1/48 kHz	48 – 192 kbps	–	.wma
MP3 (MPEG-1 Audio Layer-3)	32/44.1/48 kHz	32 – 320 kbps	–	.mp3
WAV	32/44.1/48 88.2/96/ 176.4/192 kHz	–	16 / 24 bit	.wav
MPEG-4 AAC	32/44.1/48 kHz	16 – 320 kbps	–	.aac/ .m4a/ .mp4
FLAC (Free Lossless Audio Codec)	32/44.1/48/ 88.2/96/ 176.4/192 kHz	–	16 / 24 bit	.flac

NOTE

Particularly when you play back large music files, depending on your wireless LAN environment, the playback sound may be interrupted. In this case, make the wired LAN connection.

□ About Last.fm

Last.fm learns what you love... and it's a great way to discover new music.

Your new DENON Network audio player is very clever. You can create a free Last.fm profile when you start using your DENON Network audio player and magically keep track of all the songs you hear.

When you sign in at www.last.fm, you can see your top music charts, view thousands of reviews, biographies and artwork, and get recommendations for local performances you won't want to miss.

With an affordable subscription you can enjoy an endless choice of personalised ad-free radio stations. Check out www.last.fm/ subscribe today for more details.

Your subscription also gives you access to Last.fm radio on a great range of music products, including your DENON Network audio player. This feature is not available in all countries. Visit www.last.fm/hardware to find out more.

Explanation terms

A

AES (Advanced Encryption Standard)

This is a next generation standard encryption method replacing the current DES and 3DES, and because of its high security it is expected to be applied widely to wireless LANs in the future. It uses the "Rijndael" algorithm developed by two Belgian cryptographers to divide the data into blocks of fixed lengths and encrypt each block. It supports data lengths of 128, 192 and 256 bits and key lengths of 128, 192 and 256 bits as well, offering extremely high encryption security.

AirPlay

AirPlay sends (plays) contents recorded in iTunes or on an iPhone/iPod touch to a compatible device via the network.

B

Bit rate

This expresses the read amount per 1 second of video/audio data recorded in a disc. A larger number means higher sound quality, but also means a larger file size.

D

DLNA

DLNA and DLNA CERTIFIED are trademarks and/or service marks of Digital Living Network Alliance. Some contents may not be compatible with other DLNA CERTIFIED™ products.

F

FLAC

FLAC stands for Free lossless Audio Codec, and is a lossless free audio file format. Lossless means that the audio is compressed without any loss in quality. The FLAC license is as shown below.

Copyright (C) 2000,2001,2002,2003,2004,2005,2006,2007,2008,2009 Josh Coalson

Redistribution and use in source and binary forms, with or without modification, are permitted provided that the following conditions are met:

- Redistributions of source code must retain the above copyright notice, this list of conditions and the following disclaimer.
- Redistributions in binary form must reproduce the above copyright notice, this list of conditions and the following disclaimer in the documentation and/or other materials provided with the distribution.
- Neither the name of the Xiph.org Foundation nor the names of its contributors may be used to endorse or promote products derived from this software without specific prior written permission.

THIS SOFTWARE IS PROVIDED BY THE COPYRIGHT HOLDERS AND CONTRIBUTORS "AS IS" AND ANY EXPRESS OR IMPLIED WARRANTIES, INCLUDING, BUT NOT LIMITED TO, THE IMPLIED WARRANTIES OF MERCHANTABILITY AND FITNESS FOR A PARTICULAR PURPOSE ARE DISCLAIMED. IN NO EVENT SHALL THE FOUNDATION OR CONTRIBUTORS BE LIABLE FOR ANY DIRECT, INDIRECT, INCIDENTAL, SPECIAL, EXEMPLARY, OR CONSEQUENTIAL DAMAGES (INCLUDING, BUT NOT LIMITED TO, PROCUREMENT OF SUBSTITUTE GOODS OR SERVICES; LOSS OF USE, DATA, OR PROFITS; OR BUSINESS INTERRUPTION) HOWEVER CAUSED AND ON ANY THEORY OF LIABILITY, WHETHER IN CONTRACT, STRICT LIABILITY, OR TORT (INCLUDING NEGLIGENCE OR OTHERWISE) ARISING IN ANY WAY OUT OF THE USE OF THIS SOFTWARE, EVEN IF ADVISED OF THE POSSIBILITY OF SUCH DAMAGE.

I

IEEE 802.11b

This is one wireless LAN standard set by the 802 working group that establishes LAN technology standards at the IEEE (Institute of Electrical and Electronics Engineers) of the United States. It uses the 2.4 GHz band usable freely without a radio frequency license (ISM band), enabling communications at a maximum speed of 11 Mbps.

- The value indicated above is the maximum theoretical value for the wireless LAN standard, and does not indicate the actual data transfer rate.

IEEE 802.11g

This is another wireless LAN standard set by the 802 working group that establishes LAN technology standards at the IEEE (Institute of Electrical and Electronics Engineers) of the United States, and is compatible with IEEE 802.11b. It also uses the 2.4 GHz band, but enables communications at a maximum speed of 54 Mbps.

- The value indicated above is the maximum theoretical value for the wireless LAN standard, and does not indicate the actual data transfer rate.

iTunes

iTunes is the name of the multimedia player provided by Apple Inc. It enables management and playback of multimedia contents including music and movies. iTunes supports many main file formats including AAC, WAV, and MP3.

M

MP3 (MPEG Audio Layer-3)

This is an internationally standardized audio data compression scheme, using the "MPEG-1" video compression standard. It compresses the data volume to about one eleventh its original size while maintaining sound quality equivalent to a music CD.

MPEG (Moving Picture Experts Group), MPEG-2, MPEG-4

These are the names for digital compression format standards used for the encoding of video and audio. Video standards include "MPEG-1 Video", "MPEG-2 Video", "MPEG-4 Visual", "MPEG-4 AVC". Audio standards include "MPEG-1 Audio", "MPEG-2 Audio", "MPEG-4 AAC".

N

Network Names

(SSID: Security Set Identifier)

When forming wireless LAN networks, groups are formed to prevent interference, data theft, etc. This grouping is done by "SSID" or "Security Set Identifiers". For further security, a WEP key is set and signal transfer is not possible unless the SSID and WEP key match.

S

Sampling frequency

Sampling involves taking a reading of a sound wave (analog signal) at regular intervals and expressing the height of the wave at each reading in digitized format (producing a digital signal).

The number of readings taken in one second is called the "sampling frequency". The larger the value, the closer the reproduced sound is to the original.

T

TKIP (Temporal Key Integrity Protocol)

This is a network key used for WPA. The encryption algorithm is RC4, the same as for WEP, but the security level is increased by changing the network key used for encryption for each packet.

V

vTuner

This is a free online content server for Internet radio. Note that usage fees are included in upgrade costs.

For inquiries about this service, visit the vTuner site below.

vTuner website: <http://www.radiodemon.com>

This product is protected by certain intellectual property rights of Nothing Else Matters Software and BridgeCo. Use or distribution of such technology outside of this product is prohibited without a license from Nothing Else Matters Software and BridgeCo or an authorized subsidiary.

W

WEP Key (Network Key)

This is key information used for encrypting data when conducting data transfer. On this unit, the same WEP key is used for data encryption and decryption, so the same WEP key must be set on both devices in order for communications to be established between them.

Wi-Fi®

Wi-Fi Certification assures tested and proven interoperability by the Wi-Fi Alliance, a group certifying interoperability among wireless LAN devices.

Windows Media DRM

This is a copyright protection technology developed by Microsoft.

Content providers are using the digital rights management technology for Windows Media contained in this device (WM-DRM) to protect the integrity of their content (Secure Content) so that their intellectual property, including copyright, in such content is not misappropriated. This device uses WM-DRM software to play Secure Content (WM-DRM Software). If the security of the WM-DRM Software in this device has been compromised, owners of Secure Content (Secure Content Owners) may request that Microsoft revoke the WM-DRM Software's right to acquire new licenses to copy, display and/or play Secure Content. Revocation does not alter the WM-DRM Software's ability to play unprotected content.

A list of revoked WM-DRM Software is sent to your device whenever you download a license for Secure Content from the Internet or from a PC.

Microsoft may, in conjunction with such license, also download revocation list onto your device on behalf of Secure Content Owners.

Windows Media Player Ver. 11 or later

This is a media player distributed free of charge by Microsoft Corporation.

It can be used to play playlists created with Windows Media Player Ver. 11 or later as well as files in such formats as WMA, DRM WMA, MP3 and WAV.

WMA (Windows Media Audio)

This is audio compression technology developed by Microsoft Corporation.

WMA data can be encoded using Windows Media® Player Ver.7, 7.1, Windows Media® Player for Windows® XP and Windows Media® Player 9 Series.

To encode WMA files, only use applications authorized by Microsoft Corporation. If you use an unauthorized application, the file may not work properly.

WPA (Wi-Fi Protected Access)

This is a security standard established by the Wi-Fi Alliance. In addition to the conventional SSID (network name) and WEP key (network key), it also uses a user identification function and encrypting protocol for stronger security.

WPA2 (Wi-Fi Protected Access 2)

This is a new version of the WPA established by the Wi-Fi Alliance, compatible with more secure AES encryption.

WPA-PSK/WPA2-PSK (Pre-shared Key)

This is a simple authentication system for mutual authentication when a preset character string matches on the wireless LAN access point and client.

WPS (Wi-Fi Protected Setup)

This is a standard drawn up by the Wi-Fi Alliance to ease the task of setting up wireless LAN connections and configuring security. There are two methods: push-button and PIN (Personal Identification Number) code.

Troubleshooting

If a problem occurs first check the following:

1. Are the connections correct?
2. Is the set being operated as described in the owner's manual?
3. Are the other devices operating properly?

If this unit does not operate properly, check the items listed in the table below. If the problem persists, there may be a malfunction.

In this case, disconnect the power immediately and contact your retail outlet.

[General]

Symptom	Cause	Countermeasure	Page
Set does not operate properly.	• External noise or interference is causing the set to malfunction.	• Reset the microprocessor.	34
Display not lit and sound not produced when power switched to on.	• Power cord not plugged in securely.	• Check the connections on the set's rear panel and the connection of the power plug to the power outlet.	9
Display lit but sound not produced.	• Wrong input source selected.	• Select the appropriate input source.	20
Display is off.	• The Dimmer setting is set to "Off".	• Set to something other than "Off".	20
Power turns off suddenly and POWER indicator flashes red. (Flashes at 0.25 second intervals)	• Set is damaged.	• Turn off the power and contact a DENON service center.	—
"No Network Connection" is displayed.	• The network is not properly set up.	• Select a source other than the network function. • Perform "Quick Setup."	20 10

[Internet radio/Music server/iPod/USB memory device]

Symptom	Cause	Countermeasure	Page
When a USB memory device is connected, "iPod/USB" is not displayed.	• The set cannot recognize a USB memory device.	• Check the connection.	28
	• A USB memory device not conforming to mass storage class or MTP standards is connected.	• Connect a USB memory device conforming to mass storage class or MTP standards.	–
	• A USB memory device that the set cannot recognize is connected.	• This is not a malfunction. DENON does not guarantee that all USB memory devices will operate or receive power.	–
	• USB memory device is connected via USB hub.	• Connect the USB memory device directly to the USB port.	–
iPod cannot be played.	• The input source is set to something other than "iPod/USB".	• Switch the input source to "iPod/USB".	20
	• Cable is not properly connected.	• Reconnect.	26
Files on a USB memory device cannot be played.	• USB memory device is in a format other than FAT16 or FAT32.	• Set the format to FAT16 or FAT32. For details, refer to the USB memory device's operating instructions.	–
	• USB memory device is divided into multiple partitions.	• When divided into multiple partitions, only files stored in the top partition can be played.	–
	• Files are stored in a non-compatible format.	• Record the files in a compatible format.	39
	• You are attempting to play a file that is copyright protected.	• Files that are copyright protected cannot be played on this set.	39
Internet radio cannot be played.	• Ethernet cable is not properly connected or network is disconnected.	• Check the connection status.	8
	• Program is being broadcast in non-compatible format.	• Only Internet radio programs in MP3 and WMA can be played on this set.	40
	• The computer's or router's firewall is activated.	• Check the computer's or router's firewall settings.	–
	• Radio station is not currently broadcasting.	• Choose a radio station that is currently broadcasting.	21
	• IP address is wrong.	• Check the set's IP address.	10

Symptom	Cause	Countermeasure	Page
Files stored on a computer cannot be played.	• Files are stored in a non-compatible format.	• Record in a compatible format.	40
	• You are attempting to play a file that is copyright protected.	• Files that are copyright protected cannot be played on this set.	40
	• Set and computer are connected by USB cable.	• The set's USB port cannot be used for connection to a computer.	–
Server is not found, or it is not possible to connect to the server.	• The computer's or router's firewall is activated.	• Check the computer's or router's firewall settings.	–
	• Computer's power is not turned on.	• Turn on the power.	–
	• Server is not running.	• Launch the server.	–
	• Set's IP address is wrong.	• Check the set's IP address.	10
Cannot connect to favorite radio stations.	• Radio station is not currently broadcasting.	• Wait a while before trying again.	–
	• Radio station is not currently in service.	• It is not possible to connect to radio stations that are no longer in service.	–
For some radio stations, "Server Full" or "Connection Down" is displayed and station cannot be connected to.	• Station is congested or not currently broadcasting.	• Wait a while before trying again.	–
	• Network's signal transfer speed is slow or communications lines or radio station is congested.	• This is not a malfunction. When playing broadcast data with a high bit rate, the sound may be broken, depending on the communications conditions.	–
Sound is broken during playback.	• Network's signal transfer speed is slow or communications lines or radio station is congested.	• This is not a malfunction. When playing broadcast data with a high bit rate, the sound may be broken, depending on the communications conditions.	–
Sound quality is poor or played sound is noisy.	• File being played has a low bit rate.	• This is not a malfunction.	–



[Last.fm]

Symptom	Cause	Countermeasure	Page
Cannot login to Last.fm. ("Subscription required" is displayed.)	<ul style="list-style-type: none"> Login authentication error. If a nonsubscriber user accesses it. Or when the listening limitation exceeds it. 	<ul style="list-style-type: none"> Enter the correct username and password and retry login. You need to be a paid Last.fm subscriber to listen to this. Visit www.last.fm/ subscribe to upgrade. 	–
Cannot play back music. ("Library empty" is displayed.)	<ul style="list-style-type: none"> No music data to be played back. 	<ul style="list-style-type: none"> Visit www.last.fm/download and install the Scrobbler to add the music you've played to your profile and make this feature work. 	–
Cannot play back music. ("No more tracks" is displayed.)	<ul style="list-style-type: none"> When you played all tunes of the playlist. 	<ul style="list-style-type: none"> Select another playlist. 	–
Cannot access the Last.fm. ("No network Connection" is displayed.)	<ul style="list-style-type: none"> Cannot connect to the network. 	<ul style="list-style-type: none"> Check the network environment. 	8
Cannot access the Last.fm. ("Not available in your country" is displayed.)	<ul style="list-style-type: none"> You are accessing the network from a country where Last.fm radio is not available. 	<ul style="list-style-type: none"> Last.fm radio is not available in all countries. Please check www.last.fm/hardware for more information. 	–
Cannot login to Last.fm. ("Incorrect user or password" is displayed.)	<ul style="list-style-type: none"> Incorrect username or password entered for login authentication. 	<ul style="list-style-type: none"> Enter the correct username and password and retry login. 	–
Cannot create and register an account. ("Try another username" is displayed.)	<ul style="list-style-type: none"> The username has already been taken. 	<ul style="list-style-type: none"> Enter another username to create and register the account. 	–

[Wireless LAN]

Symptom	Cause	Countermeasure	Page
Cannot connect to network.	<ul style="list-style-type: none"> The settings of the SSID and network key (WEP) are incorrect. The reception is poor and the signals cannot be received. There are multiple networks and the usable channels overlap. The router power is off. 	<ul style="list-style-type: none"> Match the network settings with this unit settings. Shorten the distance from the wireless LAN's access point, remove any obstacles and otherwise improve visibility, then try reconnecting. Also install away from microwave ovens and the access points of other networks. Set the access point's channel settings away from the channels used for other networks. Alternatively, connect using a network cable. Turn on the router power. 	15, 17 –
Played sound is interrupted or sound cannot be played.	<ul style="list-style-type: none"> There are multiple networks and the usable channels overlap. 	<ul style="list-style-type: none"> Set the access point's channel settings away from the channels used for other networks. Alternatively, connect using a network cable. 	–
Connection cannot be established via WPS.	<ul style="list-style-type: none"> The encryption type on the router is set to "WEP" or "TKIP". 	<ul style="list-style-type: none"> Set the encryption type to "None", "WPA-PSK(AES)" or "WPA2-PSK(AES)" before establishing connection. 	16

[AirPlay]

Symptom	Cause	Countermeasure	Page
The AirPlay icon  is not displayed in iTunes or on the iPhone/iPod touch.	<ul style="list-style-type: none"> This unit and the computer or iPhone/iPod touch are not connected to the same network (LAN). iTunes or the iPhone/iPod touch do not have firmware that supports AirPlay installed. 	<ul style="list-style-type: none"> Connect the computer or iPhone/iPod touch to the same network as this unit. Update to the latest firmware. 	8 12
No sound.	<ul style="list-style-type: none"> This unit is not selected in the screen that is displayed when iTunes or the iPhone/iPod touch is started. 	<ul style="list-style-type: none"> Start iTunes or switch on the iPhone/iPod touch, click the AirPlay icon  in the displayed screen, and select this unit. 	30

[Remote control]

Symptom	Cause	Countermeasure	Page
Set does not work properly when remote control operated.	<ul style="list-style-type: none"> Batteries are worn. 	<ul style="list-style-type: none"> Replace with new batteries. 	3
	<ul style="list-style-type: none"> You are operating outside of the specified range. 	<ul style="list-style-type: none"> Operate within the specified range. 	3
	<ul style="list-style-type: none"> Obstacle between main unit and remote control. 	<ul style="list-style-type: none"> Remove the obstacle. 	—
	<ul style="list-style-type: none"> The batteries are not inserted in the proper direction, as indicated by the polarity marks in the battery compartment. 	<ul style="list-style-type: none"> Insert the batteries in the proper direction, following the polarity marks in the battery compartment. 	3
	<ul style="list-style-type: none"> The set's remote control sensor is exposed to strong light (direct sunlight, fluorescent light, etc.). 	<ul style="list-style-type: none"> Move the set to a place in which the remote control sensor will not be exposed to strong light. 	3

Specifications

❑ Digital audio section

• Analog output	
Channels	2 channels
Playable frequency range	2 Hz – 96 kHz
Playable frequency response	2 Hz – 50 kHz (Sampling frequency: 192 kHz) 2 Hz – 20 kHz (Sampling frequency: 44.1 kHz)
S/N	110 dB (Audible Range)
Dynamic Range	98 dB (Audible Range)
Harmonic Distortion	0.0035 % (1 kHz, Audible Range)
• Output Level	
Unbalanced	2.0 Vrms
• Digital output	
Output level (coaxial)	0.5 Vp-p, 75 Ω

❑ Wireless LAN

Network type (wireless LAN standards)	Conforming to IEEE 802.11b Conforming to IEEE 802.11g (Conforming to Wi-Fi®)*
Transfer rate	DS-SS: 11 / 5.5 / 1 Mbps (Automatic switching) OFDM: 54 / 48 / 36 / 24 / 18 / 12 / 9 / 6 Mbps (Automatic switching)
Security	SSID (Network name) WEP key (network key) (64/128 bits) WPA-PSK (TKIP/AES) WPA2-PSK (TKIP/AES)
Used frequency range	2.412 MHz – 2.472 MHz
No. of channels	Conforming to IEEE 802.11b : 13ch (DS-SS) (Of which 1 channel used) Conforming to IEEE 802.11g : 13ch (OFDM) (Of which 1 channel used)

❑ Power supply

Power supply voltage/frequency	AC 230 V, 50/60 Hz
Power consumption	16 W
Power consumption in standby mode	0.2 W
Power consumption in "Network Control" – "On" mode	6 W

* Wi-Fi® conformity indicates tested and proven interoperability by the "Wi-Fi Alliance", a group certifying interoperability among wireless LAN devices.

- For purposes of improvement, specifications and design are subject to change without notice.

Index

A

Accessories	2
Add New Feature	13
AES	17, 41
AirPlay	30, 32, 41
Auto-Standby	11

B

Bit rate	39, 40, 41
Browse mode	26

C

Cable	
Audio cable	6
Coaxial digital cable	6
Ethernet cable	8
System cable	6
Characters	16, 17, 32, 33, 34
Connection	
Amplifier	6
AV receiver	6
D/A converter	6
Network	8
Power cord	9

D

Display's brightness	20
DLNA	41

F

Favorite list	25
Firmware Update	12
FLAC	41
Friendly Name	18
Front panel	36, 37

I

IEEE 802.11b	41
IEEE 802.11g	41
Input source	20
Inputting characters	32, 33
Internet radio	21
iTunes	30, 32, 41

L

Last.fm	24
Last.fm Display	18

M

Menu map	10
MP3	39, 40, 41
MPEG	41
MPEG-4 AAC	39
Music server	23

N

Network Control	18
Network Names (SSID)	41

P

Playback	
Internet radio	21
iPod	26
Last.fm	24
Music server	23
Network audio	21, 40
Random	28
Repeat	28
USB memory device	28, 39

R

Remote control	3, 37, 38
Battery	3
Remote mode	26
Resetting the microprocessor	34

S

Sampling frequency	39, 40, 41
Setting	
Network	11, 14, 16, 17
Other	11

T

TKIP	41
------------	----

U

Update Notification	12
Upgrade Notification	12

V

vTuner	40, 41
--------------	--------

W

WEP Key	17, 42
Wi-Fi	42
Windows Media DRM	40, 42
Windows Media Player	23, 42
WMA	39, 40, 42
WPA	17, 42
WPA2	17, 42
WPA-PSK/WPA2-PSK	17, 42
WPS	17, 42

Dimensions

Unit : mm

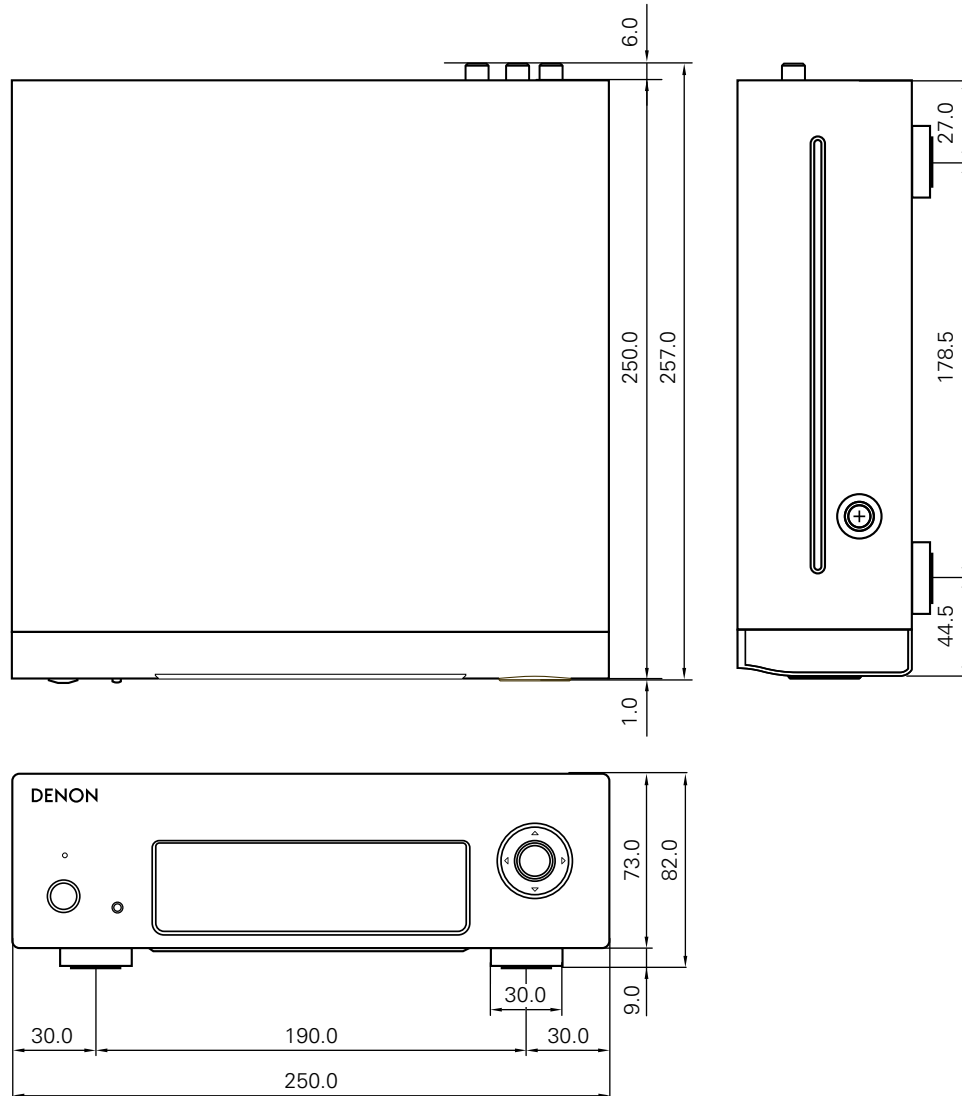

Weight : 2.0 kg

